



Power line chokes

Current-compensated ring core double chokes
250 V AC, 0.5 ... 6 A, 1.8 ... 100 mH

Series/Type: **B82724B**

Date: October 2008



Rated voltage 250 V AC
Rated current 0.5 A to 6 A
Rated inductance 1.8 mH to 100 mH



Construction

- Current-compensated ring core double choke
- Ferrite core
- Polycarbonate case (UL 94 V-0)
- Polyurethane potting (UL 94 V-0)
- Sector winding

Features

- High resonance frequency due to special winding technique
- High inductance values at compact design
- Approx. 1% stray inductance for symmetrical interference suppression
- Suitable for wave soldering
- Design complies with EN 60938-2 (VDE 0565-2)
- UL and/or VDE approvals  
- RoHS-compatible

Applications

- Suppression of common-mode interferences
- Electronic ballasts in lamps
- Switch-mode power applications

Terminals

- Base material CuNi18Zn20
- Layer composition Ni, Sn
- Hot-dipped
- Pins 0.7 × 0.7 (mm)
- Lead spacing 30 × 20 (mm)

Marking

Manufacturer, approval signs and/or VDE standard number, ordering code, graphic symbol, rated current, rated voltage, rated inductance, date of manufacture (YYWWD)

Delivery mode

Blister tray in cardboard box

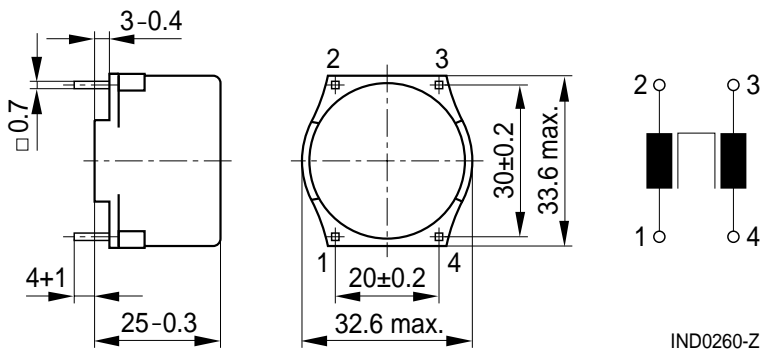
Dimensional drawing and pin configuration



Tolerances to ISO 2768-C unless otherwise noted.

Dimensions in mm

Technical data and measuring conditions

Rated voltage V_R	250 V AC (50/60 Hz)
Test voltage V_{test}	1500 V AC, 2 s (line/line)
Rated temperature T_R	40 °C / 50 °C / 60 °C
Rated current I_R	Referred to 50 Hz and rated temperature
Rated inductance L_R	Measured with Agilent 4284A at 10 kHz, 0.1 mA, 20 °C Inductance is specified per winding.
Inductance tolerance	±30% at 20 °C
Inductance decrease $\Delta L/L_0$	< 10% at DC magnetic bias with I_R , 20 °C
Stray inductance $L_{stray,typ}$	Measured with Agilent 4284A at 10 kHz, 5 mA, 20 °C, typical values
DC resistance R_{typ}	Measured at 20 °C, typical values, specified per winding
Solderability (lead-free)	Sn96.5Ag3.0Cu0.5: (245 ±5) °C, (3 ±0.3) s Wetting of soldering area ≥ 95% (to IEC 60068-2-20, test Ta)
Resistance to soldering heat (wave soldering)	(260 ±5) °C, (10 ±1) s (to IEC 60068-2-20, test Tb)
Climatic category	40/125/56 (to IEC 60068-1)
Storage conditions (packaged)	-25 °C ... +40 °C, ≤ 75% RH
Weight	Approx. 35 g ... 46 g
Approvals	EN 60938-2, UL 1283

Characteristics and ordering codes

I_R A	L_R mH	$L_{\text{stray,typ}}$ μH	R_{typ} m Ω	T_R $^{\circ}\text{C}$	Ordering code	Approvals	
							
0.5	100	950	2800	60	B82724B2501N001	×	×
1.0	47	450	880	60	B82724B2102N001	×	×
1.5	49	450	530	50	B82724B2152N020	×	—
1.8	33	280	400	40	B82724B2182N021	×	—
2.0	27	220	260	60	B82724B2202N020	—	—
2.0	10	100	220	60	B82724B2202N001	×	×
4.0	7	40	65	40	B82724B2402N030	—	—
4.0	3.9	35	58	60	B82724B2402N001	×	×
6.0	1.8	10	23	60	B82724B2602N001	×	×

× = approval granted

Current-compensated ring core double chokes

Impedance $|Z|$ versus frequency f
measured with windings in parallel at 20 °C,
typical values

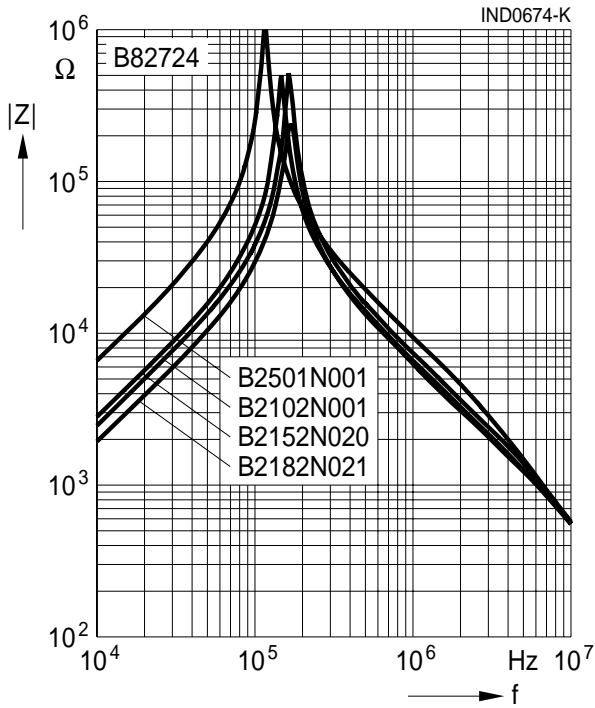

Impedance $|Z|$ versus frequency f
measured with windings in parallel at 20 °C,
typical values

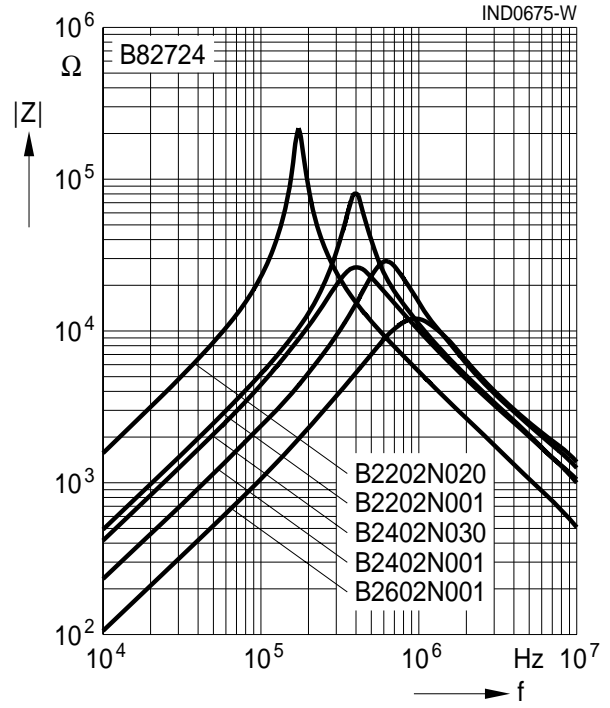

Current derating I_{op}/I_R
versus temperature T_A

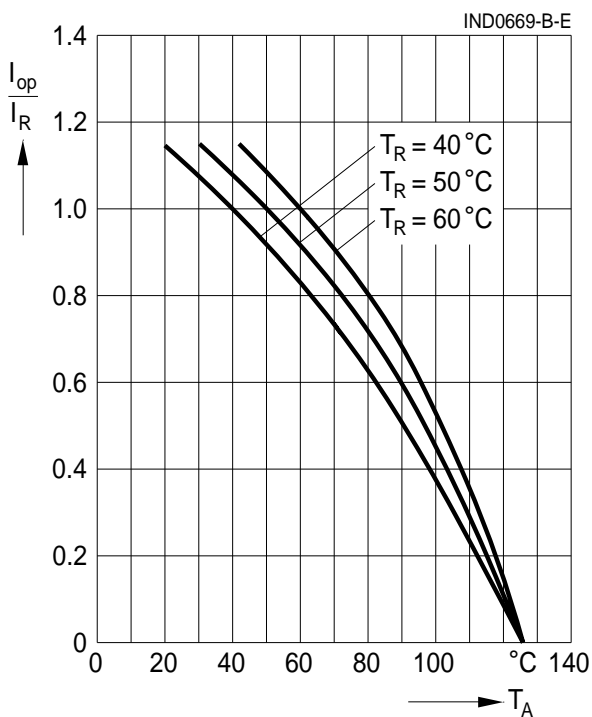

Cautions and warnings

- Please note the recommendations in our Inductors data book (latest edition) and in the data sheets.
 - Particular attention should be paid to the derating curves given there.
 - The soldering conditions should also be observed. Temperatures quoted in relation to wave soldering refer to the pin, not the housing.
- If the components are to be washed varnished it is necessary to check whether the washing varnish agent that is used has a negative effect on the wire insulation, any plastics that are used, or on glued joints. In particular, it is possible for washing varnish agent residues to have a negative effect in the long-term on wire insulation.
- The following points must be observed if the components are potted in customer applications:
 - Many potting materials shrink as they harden. They therefore exert a pressure on the plastic housing or core. This pressure can have a deleterious effect on electrical properties, and in extreme cases can damage the core or plastic housing mechanically.
 - It is necessary to check whether the potting material used attacks or destroys the wire insulation, plastics or glue.
 - The effect of the potting material can change the high-frequency behaviour of the components.
- Ferrites are sensitive to direct impact. This can cause the core material to flake, or lead to breakage of the core.
- Even for customer-specific products, conclusive validation of the component in the circuit can only be carried out by the customer.

Important notes

The following applies to all products named in this publication:

1. Some parts of this publication contain **statements about the suitability of our products for certain areas of application**. These statements are based on our knowledge of typical requirements that are often placed on our products in the areas of application concerned. We nevertheless expressly point out **that such statements cannot be regarded as binding statements about the suitability of our products for a particular customer application**.

As a rule, EPCOS is either unfamiliar with individual customer applications or less familiar with them than the customers themselves. For these reasons, it is always ultimately incumbent on the customer to check and decide whether an EPCOS product with the properties described in the product specification is suitable for use in a particular customer application.

2. We also point out that **in individual cases, a malfunction of electronic components or failure before the end of their usual service life cannot be completely ruled out in the current state of the art, even if they are operated as specified**. In customer applications requiring a very high level of operational safety and especially in customer applications in which the malfunction or failure of an electronic component could endanger human life or health (e.g. in accident prevention or life-saving systems), it must therefore be ensured by means of suitable design of the customer application or other action taken by the customer (e.g. installation of protective circuitry or redundancy) that no injury or damage is sustained by third parties in the event of malfunction or failure of an electronic component.
3. **The warnings, cautions and product-specific notes must be observed.**
4. In order to satisfy certain technical requirements, **some of the products described in this publication may contain substances subject to restrictions in certain jurisdictions (e.g. because they are classed as hazardous)**. Useful information on this will be found in our Material Data Sheets on the Internet (www.epcos.com/material). Should you have any more detailed questions, please contact our sales offices.
5. We constantly strive to improve our products. Consequently, **the products described in this publication may change from time to time**. The same is true of the corresponding product specifications. Please check therefore to what extent product descriptions and specifications contained in this publication are still applicable before or when you place an order.

We also **reserve the right to discontinue production and delivery of products**. Consequently, we cannot guarantee that all products named in this publication will always be available.

The aforementioned does not apply in the case of individual agreements deviating from the foregoing for customer-specific products.

6. Unless otherwise agreed in individual contracts, **all orders are subject to the current version of the “General Terms of Delivery for Products and Services in the Electrical Industry” published by the German Electrical and Electronics Industry Association (ZVEI)**.
7. The trade names EPCOS, BAOKE, Alu-X, CeraDiode, CSMP, CSSP, CTVS, DSSP, MiniBlue, MKK, MLSC, MotorCap, PCC, PhaseCap, PhaseCube, PhaseMod, SIFERRIT, SIFI, SIKOREL, SilverCap, SIMDAD, SIMID, SineFormer, SIOV, SIP5D, SIP5K, ThermoFuse, WindCap are **trademarks registered or pending** in Europe and in other countries. Further information will be found on the Internet at www.epcos.com/trademarks.