



Inductors

VHF chokes

Series/Type: B82131, B82132, B82133, B82134

Date: March 2008

Rated voltage 500 V AC/DC
Rated current 0.15 A to 6 A
Rated inductance 1 μ H to 420 μ H



Construction

- Cylinder core of carbonyl iron
- Winding: single-layer, enamel copper wire
- Polyester insulating sleeve

Features

- High resonant frequency
- Design complies with EN 60938
- Suitable for wave soldering
- RoHS-compatible

Applications

- RF blocking and filtering
- Interference suppression in small appliances
- Decoupling in telecommunications and entertainment electronics

Terminals

- Central axial leads
- Base material Cu
- Hot-dip tinned with pure tin

Marking

L_R and I_R in clear text

Delivery mode and packing units

- Taped and reeled
- Packing units:

Series	Pcs./reel
B82131, B82132	2000
B82133, B82134	1000

Dimensional drawing

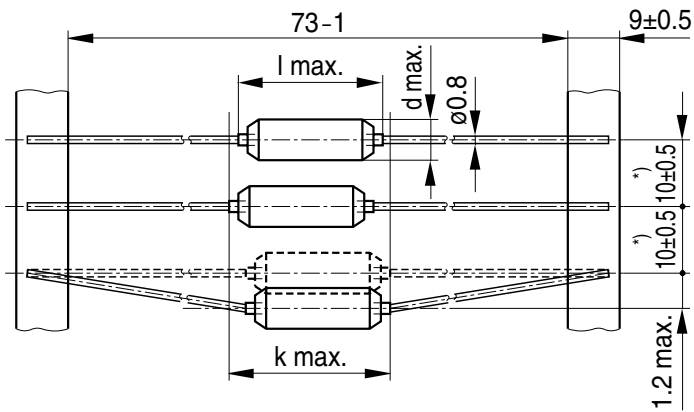

*) Tolerance over 10 spacings ±2 mm

IND0144-Z-E

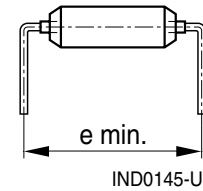

IND0145-U

Lead spacing e_{min} (mm)	Type
17.5	B82131
22.5	B82132
27.5	B82133
32.5	B82134

Dimensions in mm

Reel packing

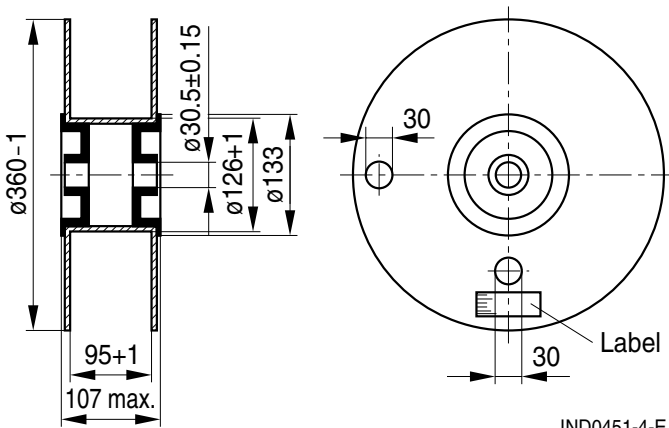

IND0451-4-E

Dimensions in mm

Technical data and measuring conditions

Test voltage V_{test}	2500 V AC, 1 min
Rated inductance L_R	Measured with LCR meter Agilent 4284A or impedance analyzer Agilent 4294A Measuring frequency: $L_R \leq 10 \mu\text{H}$ = 1 MHz $10 \mu\text{H} < L_R \leq 1000 \mu\text{H}$ = 100 kHz Measuring voltage: 1 V Measuring temperature: 20 °C
Inductance tolerance	±20%
Rated temperature T_R	60 °C
Rated current I_R	Maximum permissible DC current at rated temperature
DC resistance R_{typ}	Measured at 20 °C, tolerance ±20%, typical values
Resonance frequency f_{res}	Measured with Agilent 4294A or 8753ES, 20 °C, tolerance ±30%
Solderability (lead-free)	Sn95.5Ag3.8Cu0.7: (245 ±5) °C, (3 ±0.3) s Wetting of soldering area ≥ 90% (to IEC 60068-2-20, test Ta)
Resistance to soldering heat (wave soldering)	(260 ±5) °C, 10 s (to IEC 60068-2-20, test Tb)
Tensile strength of leads	≥ 30 N (to IEC 60068-2-21, test Ua)
Climatic category	55/125/56 (to IEC 60068-1)
Storage conditions	Mounted: -55 °C ... +125 °C Packaged: -25 °C ... +40 °C, ≤ 75% RH

 **Mounting information**

When bending the leads, take care that the bending point is **at least 3 mm** apart from the face ends of the core and that the start-of-winding areas are not subjected to any mechanical stress.

Characteristics and ordering codes

I _R	L _R	R _{typ}	f _{res}	Dimensions (mm)				Approx. weight g	Ordering code
				d _{max}	l _{max}	k _{max}	e _{min}		
A	μH	Ω	MHz						
0.15	80	11	22	5	15	16.4	17.5	0.8	B82131A5151M000
	160	17	20	5.5	20	21.4	22.5	0.9	B82132A5151M000
	350	21	11	7.5	25	26.4	27.5	2.3	B82133A5151M000
	420	19	12	7.5	30	31.4	32.5	2.6	B82134A5151M000
0.3	40	4.1	31	5	15	16.4	17.5	0.8	B82131A5301M000
	70	5.7	29	5.5	20	21.4	22.5	0.9	B82132A5301M000
	160	6.5	16	7.5	25	26.4	27.5	2.2	B82133A5301M000
	210	6.4	18	7.5	30	31.4	32.5	2.8	B82134A5301M000
0.4	27	2.0	40	5	15	16.4	17.5	0.8	B82131A5401M000
	50	3.0	37	5.5	20	21.4	22.5	1.0	B82132A5401M000
	130	4.8	18	7.5	25	26.4	27.5	2.8	B82133A5401M000
	150	3.5	18	7.5	30	31.4	32.5	2.8	B82134A5401M000
0.7	14	0.76	53	5	15	16.4	17.5	0.8	B82131A5701M000
	23	0.73	55	5.5	20	21.4	22.5	1.0	B82132A5701M000
	55	1.20	26	7.5	25	26.4	27.5	2.4	B82133A5701M000
	60	0.77	34	7.5	30	31.4	32.5	3.0	B82134A5701M000
1.5	6	0.19	84	5	15	16.4	17.5	0.8	B82131A5152M000
	8	0.16	90	5.5	20	21.4	22.5	1.1	B82132A5152M000
	25	0.32	40	7.5	25	26.4	27.5	2.5	B82133A5152M000
	30	0.30	44	7.5	30	31.4	32.5	3.2	B82134A5152M000
2	3	0.09	113	5	15	16.4	17.5	0.8	B82131A5202M000
	6	0.11	108	5.5	20	21.4	22.5	1.1	B82132A5202M000
	14	0.13	57	7.5	25	26.4	27.5	2.8	B82133A5202M000
	20	0.15	59	7.5	30	31.4	32.5	3.3	B82134A5202M000
3	2	0.038	147	5	15	16.4	17.5	1.0	B82131A5302M000
	3	0.035	151	5.5	20	21.4	22.5	1.2	B82132A5302M000
	10	0.077	69	7.5	25	26.4	27.5	2.9	B82133A5302M000
	12	0.090	75	7.5	30	31.4	32.5	3.5	B82134A5302M000
4	1	0.014	199	5	15	16.4	17.5	1.1	B82131A5402M000
	2	0.020	186	5.5	20	21.4	22.5	1.4	B82132A5402M000
	5	0.034	87	7.5	25	26.4	27.5	3.0	B82133A5402M000

Impedance |Z| versus frequency f

measured with impedance analyzer Agilent 4294A or S-parameter network analyzer Agilent 8753ES, typical values at 20 °C

B82131A5***M000

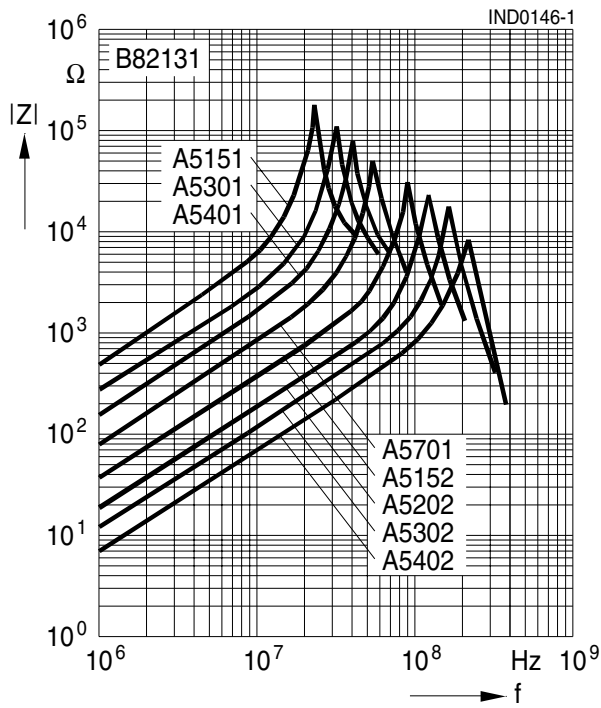

B82132A5***M000

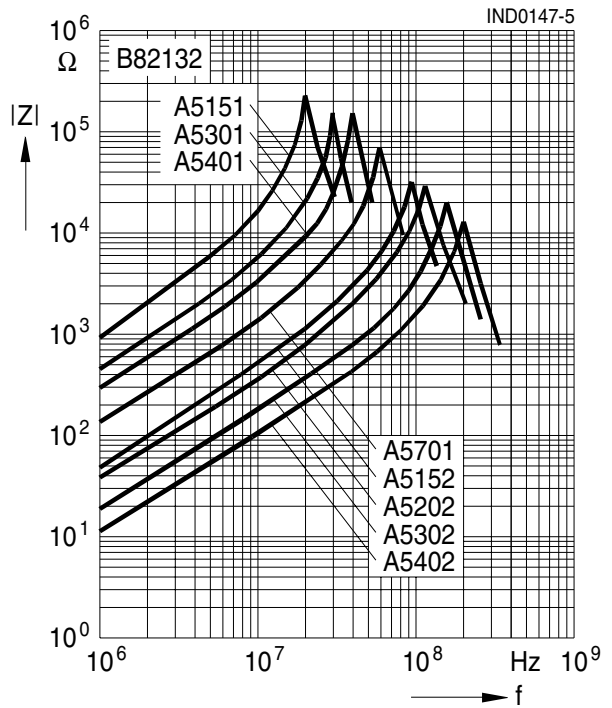

B82133A5***M000

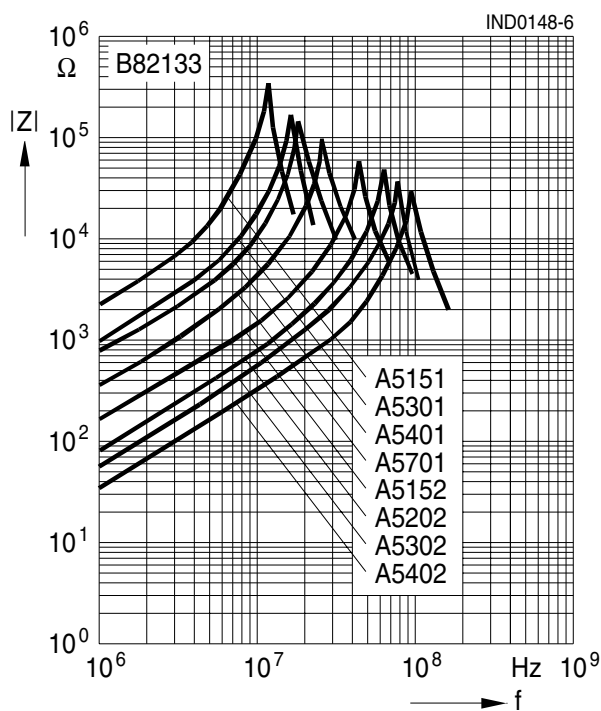

B82134A5***M000

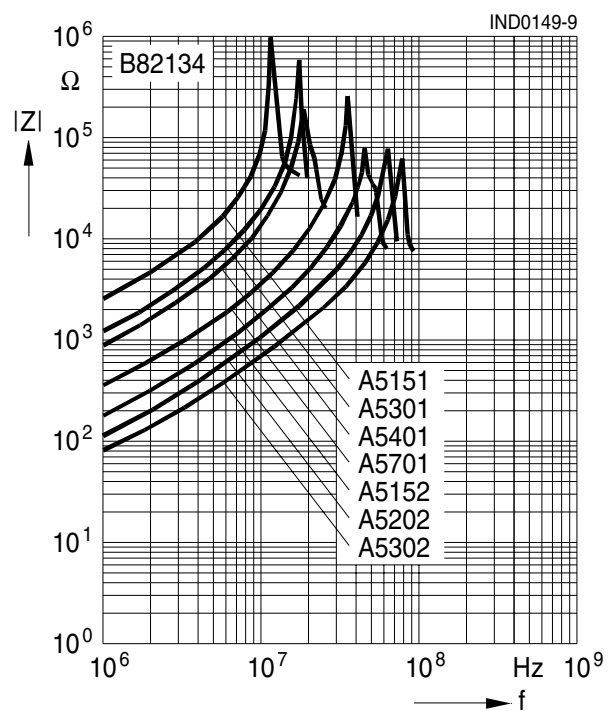

**Current derating I_{op}/I_R
versus ambient temperature T_A**
(rated temperature $T_R = 60\text{ °C}$)

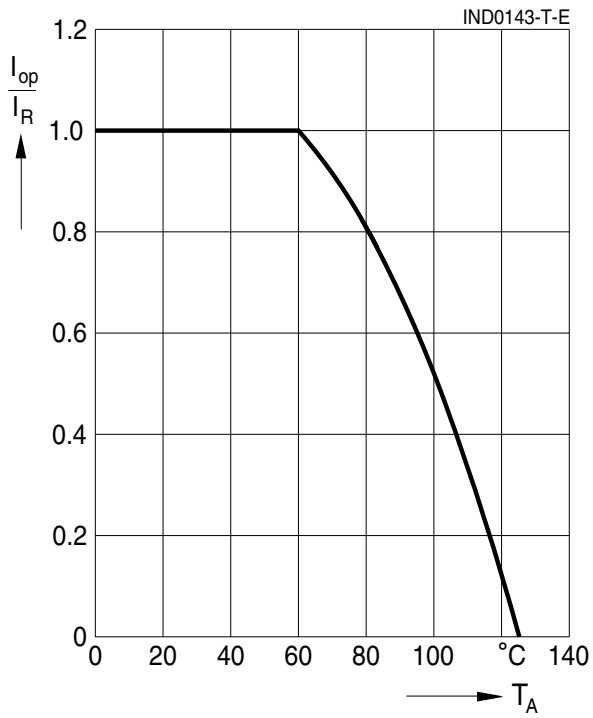

Cautions and warnings

- Please note the recommendations in our Inductors data book (latest edition) and in the data sheets.
 - Particular attention should be paid to the derating curves given there.
 - The soldering conditions should also be observed. Temperatures quoted in relation to wave soldering refer to the pin, not the housing.
- If the components are to be washed varnished it is necessary to check whether the washing varnish agent that is used has a negative effect on the wire insulation, any plastics that are used, or on glued joints. In particular, it is possible for washing varnish agent residues to have a negative effect in the long-term on wire insulation.
- The following points must be observed if the components are potted in customer applications:
 - Many potting materials shrink as they harden. They therefore exert a pressure on the plastic housing or core. This pressure can have a deleterious effect on electrical properties, and in extreme cases can damage the core or plastic housing mechanically.
 - It is necessary to check whether the potting material used attacks or destroys the wire insulation, plastics or glue.
 - The effect of the potting material can change the high-frequency behaviour of the components.
- Ferrites are sensitive to direct impact. This can cause the core material to flake, or lead to breakage of the core.
- Even for customer-specific products, conclusive validation of the component in the circuit can only be carried out by the customer.

Important notes

The following applies to all products named in this publication:

1. Some parts of this publication contain **statements about the suitability of our products for certain areas of application**. These statements are based on our knowledge of typical requirements that are often placed on our products in the areas of application concerned. We nevertheless expressly point out **that such statements cannot be regarded as binding statements about the suitability of our products for a particular customer application**.

As a rule, EPCOS is either unfamiliar with individual customer applications or less familiar with them than the customers themselves. For these reasons, it is always ultimately incumbent on the customer to check and decide whether an EPCOS product with the properties described in the product specification is suitable for use in a particular customer application.

2. We also point out that **in individual cases, a malfunction of electronic components or failure before the end of their usual service life cannot be completely ruled out in the current state of the art, even if they are operated as specified**. In customer applications requiring a very high level of operational safety and especially in customer applications in which the malfunction or failure of an electronic component could endanger human life or health (e.g. in accident prevention or life-saving systems), it must therefore be ensured by means of suitable design of the customer application or other action taken by the customer (e.g. installation of protective circuitry or redundancy) that no injury or damage is sustained by third parties in the event of malfunction or failure of an electronic component.
3. **The warnings, cautions and product-specific notes must be observed.**
4. In order to satisfy certain technical requirements, **some of the products described in this publication may contain substances subject to restrictions in certain jurisdictions (e.g. because they are classed as hazardous)**. Useful information on this will be found in our Material Data Sheets on the Internet (www.epcos.com/material). Should you have any more detailed questions, please contact our sales offices.
5. We constantly strive to improve our products. Consequently, **the products described in this publication may change from time to time**. The same is true of the corresponding product specifications. Please check therefore to what extent product descriptions and specifications contained in this publication are still applicable before or when you place an order.

We also **reserve the right to discontinue production and delivery of products**. Consequently, we cannot guarantee that all products named in this publication will always be available.

The aforementioned does not apply in the case of individual agreements deviating from the foregoing for customer-specific products.

6. Unless otherwise agreed in individual contracts, **all orders are subject to the current version of the “General Terms of Delivery for Products and Services in the Electrical Industry” published by the German Electrical and Electronics Industry Association (ZVEI)**.
7. The trade names EPCOS, BAOKE, Alu-X, CeraDiode, CSMP, CSSP, CTVS, DSSP, MiniBlue, MKK, MLSC, MotorCap, PCC, PhaseCap, PhaseCube, PhaseMod, SIFERRIT, SIFI, SIKOREL, SilverCap, SIMDAD, SIMID, SineFormer, SIOV, SIP5D, SIP5K, ThermoFuse, WindCap are **trademarks registered or pending** in Europe and in other countries. Further information will be found on the Internet at www.epcos.com/trademarks.