

Multilayer Chip Ceramic Inductor - SDCL0402Q-P01 Series

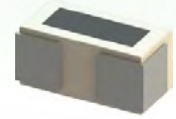

Operating Temp. : -55°C ~+125°C

FEATURES

- Monolithic structure for high reliability
- High self-resonant frequency
- Excellent solderability and high heat resistance
- High Q factor

APPLICATIONS

- RF circuit in telecommunication and other equipments

PRODUCT IDENTIFICATION

SDCL

①

Type	
SDCL	Chip Ceramic Inductor

0402

②

Q

③

External Dimensions (L×W) (mm)	
0402 [01005]	0.4×0.2

3N0

④

④

Nominal Inductance	
Example	Nominal Value
3N0	3.0nH
16N	16nH
※R=Decimal Point, N=nH	

⑤

Inductance Tolerance	
B	±0.1nH
C	±0.2nH
S	±0.3nH
H	±3%
J	±5%

B

⑤

Characteristics Code	
Q	

P

⑥

Packing	
P	Plastic

01

⑦

Serial Code	
01	

SHAPE AND DIMENSIONS

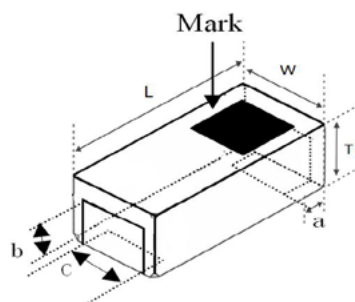

Unit: mm [inch]

Type	L	W	T	a	b	C
SDCL0402Q-P01 [01005]	0.4±0.02 [.016±.0008]	0.2±0.02 [.008±.0008]	0.23±0.02 [.009±.0008]	0.11±0.03 [.005±.0010]	0.11±0.03 [.005±.0010]	0.17±0.03 [.006±.0010]

SPECIFICATIONS

SDCL0402Q-P01 Series

Part Number	Inductance	Min. Quality Factor	L, Q Test Freq.	Typical Q @ Freq. (GHz)					Min. Self-resonant Frequency	Max. DC Resistance	Max. Rated Current
				0.5	0.8	1.8	2.0	2.4			
Units	nH	-	MHz	-					MHz	Ω	mA
Symbol	L	Q	Freq	Q					S.R.F	DCR	I _r
SDCL0402Q0N3 □ P01	0.3	14	500	/	/	/	/	/	17000	0.03	990
SDCL0402Q0N4 □ P01	0.4	14	500	/	/	/	/	/	17000	0.04	990
SDCL0402Q0N5 □ P01	0.5	14	500	/	/	/	/	/	17000	0.04	990
SDCL0402Q0N6 □ P01	0.6	14	500	20	25	36	38	45	16600	0.05	900
SDCL0402Q0N7 □ P01	0.7	14	500	20	25	36	38	45	16600	0.05	900
SDCL0402Q0N8 □ P01	0.8	14	500	20	25	37	39	46	16600	0.07	900
SDCL0402Q0N9 □ P01	0.9	14	500	19	25	36	38	45	15500	0.1	600
SDCL0402Q1N0 □ P01	1.0	14	500	19	25	36	38	45	15500	0.1	600
SDCL0402Q1N1 □ P01	1.1	14	500	19	25	36	38	45	15500	0.11	550
SDCL0402Q1N2 □ P01	1.2	14	500	19	24	35	37	44	15500	0.11	550
SDCL0402Q1N3 □ P01	1.3	14	500	19	24	35	37	44	15500	0.11	550
SDCL0402Q1N4 □ P01	1.4	14	500	19	25	36	38	45	15000	0.12	450
SDCL0402Q1N5 □ P01	1.5	14	500	19	24	35	37	43	15000	0.12	450
SDCL0402Q1N6 □ P01	1.6	14	500	19	23	35	36	43	15000	0.15	450
SDCL0402Q1N7 □ P01	1.7	14	500	19	24	35	36	43	15000	0.15	450
SDCL0402Q1N8 □ P01	1.8	14	500	19	24	35	37	44	13000	0.15	450
SDCL0402Q1N9 □ P01	1.9	14	500	19	24	35	37	44	12000	0.16	450
SDCL0402Q2N0 □ P01	2.0	14	500	19	25	35	38	45	11000	0.16	450
SDCL0402Q2N1 □ P01	2.1	14	500	19	25	35	37	44	11000	0.16	450
SDCL0402Q2N2 □ P01	2.2	14	500	19	25	35	37	43	10500	0.18	400
SDCL0402Q2N3 □ P01	2.3	14	500	19	24	34	36	43	10500	0.18	400
SDCL0402Q2N4 □ P01	2.4	14	500	19	25	37	39	46	10500	0.2	400
SDCL0402Q2N5 □ P01	2.5	14	500	19	24	35	36	43	10000	0.2	400
SDCL0402Q2N6 □ P01	2.6	14	500	19	24	35	36	43	10000	0.2	400
SDCL0402Q2N7 □ P01	2.7	14	500	19	24	37	39	43	9500	0.23	350
SDCL0402Q2N8 □ P01	2.8	14	500	19	24	37	40	46	9500	0.23	350
SDCL0402Q2N9 □ P01	2.9	14	500	19	24	36	39	45	9500	0.23	350
SDCL0402Q3N0 □ P01	3.0	14	500	19	25	36	38	45	9500	0.26	350
SDCL0402Q3N1 □ P01	3.1	14	500	19	25	35	37	43	9000	0.26	350
SDCL0402Q3N2 □ P01	3.2	14	500	19	24	35	37	44	9000	0.26	350
SDCL0402Q3N3 □ P01	3.3	14	500	19	25	36	38	45	9000	0.26	350
SDCL0402Q3N4 □ P01	3.4	14	500	19	24	35	38	44	9000	0.26	350
SDCL0402Q3N5 □ P01	3.5	14	500	19	25	36	38	45	8700	0.28	350
SDCL0402Q3N6 □ P01	3.6	14	500	19	24	35	37	44	8700	0.28	350
SDCL0402Q3N7 □ P01	3.7	14	500	19	24	35	37	44	8700	0.28	350
SDCL0402Q3N8 □ P01	3.8	14	500	19	24	34	36	42	8700	0.28	350
SDCL0402Q3N9 □ P01	3.9	14	500	18	23	33	35	39	8700	0.3	350
SDCL0402Q4N0 □ P01	4.0	14	500	18	23	33	35	40	8000	0.3	350
SDCL0402Q4N1 □ P01	4.1	14	500	18	23	33	35	40	7500	0.3	350
SDCL0402Q4N2 □ P01	4.2	14	500	18	23	34	36	41	7000	0.3	350
SDCL0402Q4N3 □ P01	4.3	14	500	18	22	33	35	40	7000	0.3	350
SDCL0402Q4N7 □ P01	4.7	14	500	18	23	34	36	42	7000	0.4	300
SDCL0402Q5N1 □ P01	5.1	14	500	17	22	32	34	37	6600	0.4	300
SDCL0402Q5N6 □ P01	5.6	14	500	17	22	31	33	36	6100	0.4	300
SDCL0402Q6N2 □ P01	6.2	14	500	17	22	32	33	38	6000	0.45	300
SDCL0402Q6N8 □ P01	6.8	14	500	17	21	30	32	35	5700	0.52	250
SDCL0402Q7N5 □ P01	7.5	14	500	16	20	29	31	34	5500	0.68	230
SDCL0402Q8N2 □ P01	8.2	14	500	17	21	30	32	35	5300	0.68	230

SDCL0402Q-P01 Series

SPECIFICATIONS

Part Number	Inductance	Min. Quality Factor	L, Q Test Freq.	Typical Q @ Freq. (GHz)					Min. Self-resonant Frequency	Max. DC Resistance	Max. Rated Current
				0.5	0.8	1.8	2.0	2.4			
Units	nH	-	MHz	-					MHz	Ω	mA
Symbol	L	Q	Freq	Q					S.R.F	DCR	I _r
SDCL0402Q9N1 □ P01	9.1	14	500	16	20	29	32	35	5000	0.8	170
SDCL0402Q10N □ P01	10	14	500	16	20	29	31	34	4500	0.85	170
SDCL0402Q11N □ P01	11	14	500	16	21	28	30	31	4200	0.9	170
SDCL0402Q12N □ P01	12	14	500	16	20	27	28	29	4000	0.93	170
SDCL0402Q13N □ P01	13	12	500	15	18	25	26	27	3800	1.2	160
SDCL0402Q15N □ P01	15	12	500	15	18	24	25	25	3500	1.8	140
SDCL0402Q16N □ P01	16	12	500	15	18	24	25	25	3500	1.8	140
SDCL0402Q18N □ P01	18	9	500	11	15	18	20	19	3000	2.5	140
SDCL0402Q20N □ P01	20	9	500	11	15	18	20	19	2700	2.8	140
SDCL0402Q22N □ P01	22	9	500	11	14	17	20	18	2300	3.5	120

Note: □ : Please specify the inductance tolerance. For $L \leq 4.2\text{nH}$, choose $B = \pm 0.1\text{nH}$, $C = \pm 0.2\text{nH}$ or $S = \pm 0.3\text{nH}$; For $4.2\text{nH} < L < 5.6\text{nH}$, choose, $H = \pm 3\%$, $J = \pm 5\%$ or $S = \pm 0.3\text{nH}$; For $L \geq 5.6\text{nH}$, choose, $H = \pm 3\%$, $J = \pm 5\%$.

TYPICAL ELECTRICAL CHARACTERISTICS

SDCL0402Q1N6BP01

Inductance vs. Frequency Characteristics

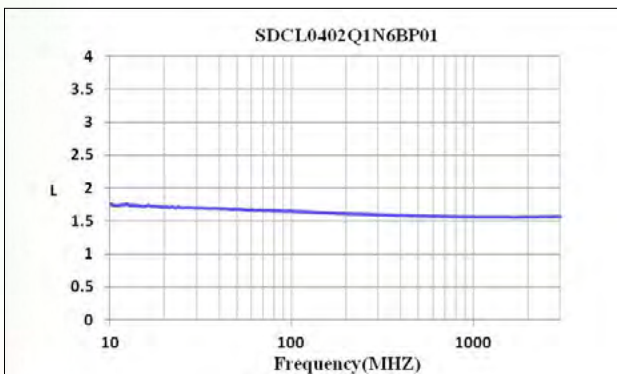

Q vs. Frequency Characteristics

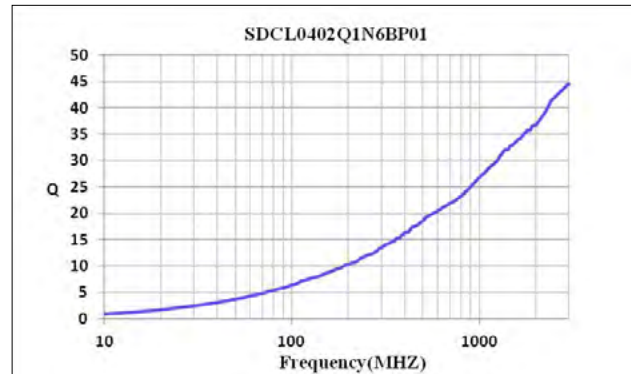

SDCL0402Q3N5BP01

Inductance vs. Frequency Characteristics

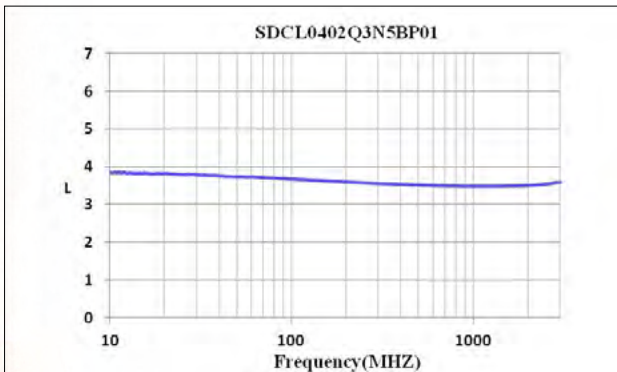

Q vs. Frequency Characteristics



TYPICAL ELECTRICAL CHARACTERISTICS

SDCL0402Q6N2HP01

Inductance vs. Frequency Characteristics

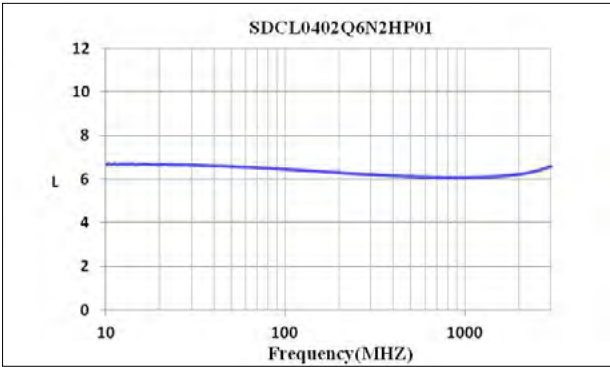

Q vs. Frequency Characteristics

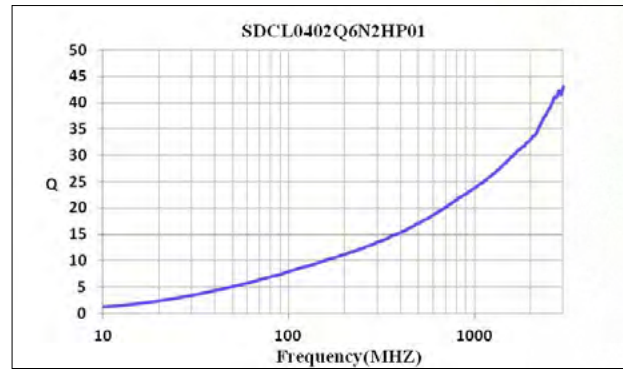

SDCL0402Q12NHP01

Inductance vs. Frequency Characteristics

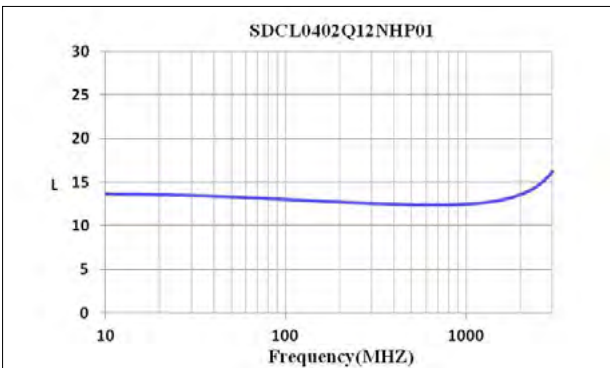

Q vs. Frequency Characteristics

