



Inductors for Standard Circuits

Multilayer Ferrite

MLF series

MLF1005	1005 [0402 inch]*
MLF1608	1608 [0603 inch]
MLF2012	2012 [0805 inch]

* Dimensions Code JIS[EIA]

REMINDERS FOR USING THESE PRODUCTS

Before using these products, be sure to request the delivery specifications.

SAFETY REMINDERS

Please pay sufficient attention to the warnings for safe designing when using these products.

REMINDERS

- The storage period is less than 12 months. Be sure to follow the storage conditions (Temperature: 5 to 40°C, Humidity: 10 to 75% RH or less).
If the storage period elapses, the soldering of the terminal electrodes may deteriorate.
- Do not use or store in locations where there are conditions such as gas corrosion (salt, acid, alkali, etc.).
- Before soldering, be sure to preheat components.
The preheating temperature should be set so that the temperature difference between the solder temperature and chip temperature does not exceed 150°C.
- Soldering corrections after mounting should be within the range of the conditions determined in the specifications.
If overheated, a short circuit, performance deterioration, or lifespan shortening may occur.
- When embedding a printed circuit board where a chip is mounted to a set, be sure that residual stress is not given to the chip due to the overall distortion of the printed circuit board and partial distortion such as at screw tightening portions.
- Self heating (temperature increase) occurs when the power is turned ON, so the tolerance should be sufficient for the set thermal design.
- Carefully lay out the coil for the circuit board design of the non-magnetic shield type.
A malfunction may occur due to magnetic interference.
- Use a wrist band to discharge static electricity in your body through the grounding wire.
- Do not expose the products to magnets or magnetic fields.
- Do not use for a purpose outside of the contents regulated in the delivery specifications.
- The products listed on this catalog are intended for use in general electronic equipment (AV equipment, telecommunications equipment, home appliances, amusement equipment, computer equipment, personal equipment, office equipment, measurement equipment, industrial robots) under a normal operation and use condition.
The products are not designed or warranted to meet the requirements of the applications listed below, whose performance and/or quality require a more stringent level of safety or reliability, or whose failure, malfunction or trouble could cause serious damage to society, person or property.
If you intend to use the products in the applications listed below or if you have special requirements exceeding the range or conditions set forth in the each catalog, please contact us.

- (1) Aerospace/Aviation equipment
- (2) Transportation equipment (cars, electric trains, ships, etc.)
- (3) Medical equipment
- (4) Power-generation control equipment
- (5) Atomic energy-related equipment
- (6) Seabed equipment
- (7) Transportation control equipment

- (8) Public information-processing equipment
- (9) Military equipment
- (10) Electric heating apparatus, burning equipment
- (11) Disaster prevention/crime prevention equipment
- (12) Safety equipment
- (13) Other applications that are not considered general-purpose applications

When designing your equipment even for general-purpose applications, you are kindly requested to take into consideration securing protection circuit/device or providing backup circuits in your equipment.

Inductors for Standard Circuits

Multilayer Ferrite

Product compatible with RoHS directive
Halogen-free
Compatible with lead-free solders

Overview of the MLF Series

FEATURES

- The lineup includes a wide inductance range.
- Highly reliable monolithic structure with multilayer integration.

APPLICATION

Smart phones, tablet terminals, tuners, LCD-TVs, PDP-TVs, audio equipment, computers, signal processing for modules etc.

PART NUMBER CONSTRUCTION

MLF	1005	L	R10	K	T	000			
Series name	LxWxH Dimensions (mm)		characteristics	Inductance (μH)		Inductance tolerance		Packaging style	Internal code
	1005	1.0x0.5x0.5		A	10N	0.010 (10nH)	J		
1608	1.6x0.8x0.8	C			K	±10%			A00
2012	2.0x1.25x0.85	D	R10	0.1	M	±20%			D00
	2.0x1.25x1.25	E	1R0	1					
		G	100	10					
		K							
		L							
		V							

OPERATING TEMPERATURE RANGE, PACKAGE QUANTITY, PRODUCT WEIGHT

Type	Temperature range*		Package quantity (pieces/reel)	Individual weight (mg)	
	Operating temperature (°C)	Storage temperature** (°C)			
	MLF1005	-55 to +125			-55 to +125
MLF1608	-40 to +85	-40 to +85	4,000	4	
MLF2012	t=0.85	-40 to +85	-40 to +85	4,000	10
	t=1.25			2,000	14

* In case the product's inductance tolerance is J, both Operating and Storage temperature ranges are -55 to +125°C.

** The Storage temperature range is for after the circuit board is mounted.

- RoHS Directive Compliant Product: See the following for more details related to RoHS Directive compliant products. <http://www.tdk.co.jp/rohs/>
- Halogen-free: Indicates that Cl content is less than 900ppm, Br content is less than 900ppm, and that the total Cl and Br content is less than 1500ppm.

• All specifications are subject to change without notice.

Overview of the MLF Series

RECOMMENDED REFLOW PROFILE

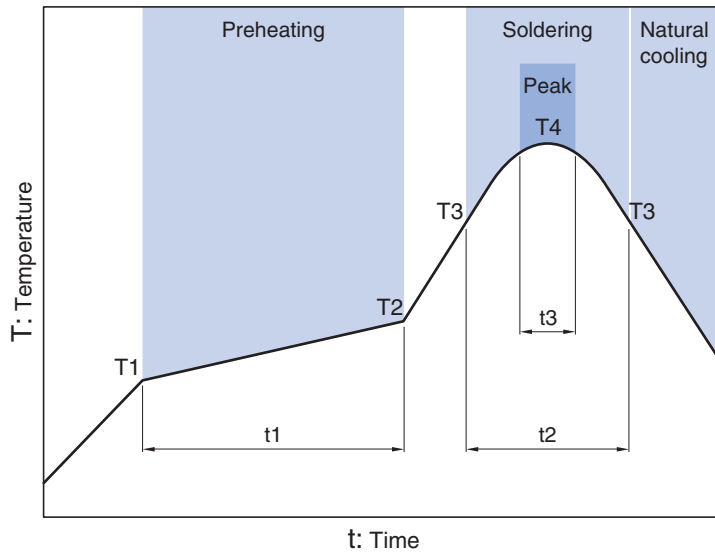

Preheating			Soldering		Peak	
Temp.	Temp.	Time	Temp.	Time	Temp.	Time
T1	T2	t1	T3	t2	T4	t3
150°C	180°C	60 to 120s	230°C	30 to 60s	250 to 260°C	10s max.

MLF series

MLF1005 Type



■ SHAPE & DIMENSIONS

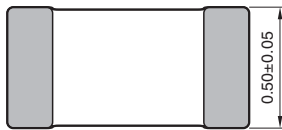
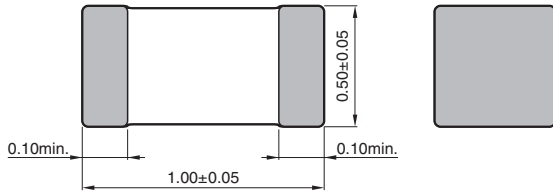

Dimensions in mm

■ RECOMMENDED LAND PATTERN

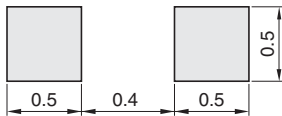

Dimensions in mm

• All specifications are subject to change without notice.

MLF series **MLF1005 Type**

■ ELECTRICAL CHARACTERISTICS

□ CHARACTERISTICS SPECIFICATION TABLE

L (μH)	Tolerance	Q		L, Q measuring conditions		Self-resonant frequency(MHz)		DC resistance (Ω)		Rated current (mA)	Part No.
		min.	typ.	Frequency (MHz)	Current (mA)	min.	typ.	max.	typ.	max.	
0.10	$\pm 5\%$	10	30	25	1.0	450	880	0.51	0.33	180	MLF1005VR10JT000
0.12	$\pm 5\%$	10	30	25	1.0	400	800	0.59	0.33	180	MLF1005VR12JT000
0.15	$\pm 5\%$	15	30	25	1.0	350	650	0.63	0.39	180	MLF1005VR15JT000
0.18	$\pm 5\%$	15	30	25	1.0	320	600	0.72	0.40	160	MLF1005VR18JT000
0.22	$\pm 5\%$	15	30	25	1.0	290	450	0.79	0.47	160	MLF1005VR22JT000
0.27	$\pm 5\%$	15	30	25	1.0	260	450	0.91	0.65	150	MLF1005VR27JT000
0.33	$\pm 5\%$	15	30	25	1.0	230	380	1.05	0.80	140	MLF1005VR33JT000
0.39	$\pm 5\%$	30	50	10	1.0	210	600	0.41	0.24	50	MLF1005GR39JT000
0.39	$\pm 5\%$	15	30	25	1.0	210	330	1.35	0.89	130	MLF1005VR39JT000
0.47	$\pm 5\%$	30	55	10	1.0	190	460	0.42	0.25	50	MLF1005GR47JT000
0.47	$\pm 5\%$	15	30	25	1.0	190	300	1.50	0.95	120	MLF1005VR47JT000
0.56	$\pm 5\%$	30	55	10	1.0	170	450	0.47	0.34	45	MLF1005GR56JT000
0.56	$\pm 5\%$	15	30	25	1.0	170	250	1.95	1.35	120	MLF1005VR56JT000
0.68	$\pm 5\%$	30	55	10	1.0	150	360	0.55	0.43	45	MLF1005GR68JT000
0.82	$\pm 5\%$	30	60	10	1.0	130	320	0.59	0.43	40	MLF1005GR82JT000
1.0	$\pm 5\%$	30	60	10	1.0	120	290	0.64	0.45	40	MLF1005G1R0JT000
1.2	$\pm 5\%$	30	60	10	1.0	110	230	0.79	0.55	35	MLF1005G1R2JT000
1.5	$\pm 5\%$	30	60	10	1.0	100	200	0.95	0.68	35	MLF1005G1R5JT000
1.8	$\pm 5\%$	30	60	10	1.0	90	180	1.05	0.75	30	MLF1005G1R8JT000
2.2	$\pm 5\%$	30	60	10	1.0	80	150	1.30	0.99	30	MLF1005G2R2JT000
0.10	$\pm 10\%$	10	25	25	1.0	450	880	0.51	0.33	180	MLF1005VR10KT000
0.12	$\pm 10\%$	10	25	25	1.0	400	800	0.59	0.33	180	MLF1005VR12KT000
0.15	$\pm 10\%$	15	25	25	1.0	350	650	0.63	0.39	180	MLF1005VR15KT000
0.18	$\pm 10\%$	15	30	25	1.0	320	600	0.72	0.40	160	MLF1005VR18KT000
0.22	$\pm 10\%$	15	30	25	1.0	290	450	0.79	0.47	160	MLF1005VR22KT000
0.27	$\pm 10\%$	15	30	25	1.0	260	450	0.91	0.65	150	MLF1005VR27KT000
0.33	$\pm 10\%$	15	30	25	1.0	230	380	1.05	0.80	140	MLF1005VR33KT000
0.39	$\pm 10\%$	30	50	10	1.0	210	600	0.41	0.24	50	MLF1005GR39KT000
0.39	$\pm 10\%$	15	30	25	1.0	210	330	1.35	0.89	130	MLF1005VR39KT000
0.47	$\pm 10\%$	30	50	10	1.0	190	460	0.42	0.25	50	MLF1005GR47KT000
0.47	$\pm 10\%$	15	30	25	1.0	190	300	1.50	0.95	120	MLF1005VR47KT000
0.56	$\pm 10\%$	30	50	10	1.0	170	450	0.47	0.34	45	MLF1005GR56KT000
0.56	$\pm 10\%$	15	30	25	1.0	170	250	1.95	1.35	120	MLF1005VR56KT000
0.68	$\pm 10\%$	30	50	10	1.0	150	360	0.55	0.43	45	MLF1005GR68KT000
0.82	$\pm 10\%$	30	50	10	1.0	130	320	0.59	0.43	40	MLF1005GR82KT000
1.0	$\pm 10\%$	30	50	10	1.0	120	290	0.64	0.45	40	MLF1005G1R0KT000
1.2	$\pm 10\%$	30	50	10	1.0	110	230	0.79	0.55	35	MLF1005G1R2KT000
1.5	$\pm 10\%$	30	50	10	1.0	100	200	0.95	0.68	35	MLF1005G1R5KT000
1.8	$\pm 10\%$	30	50	10	1.0	90	180	1.05	0.75	30	MLF1005G1R8KT000
2.2	$\pm 10\%$	30	50	10	1.0	80	150	1.30	0.99	30	MLF1005G2R2KT000

○ Measurement equipment

Measurement item	Product No.	Manufacturer
L, Q	4294A+16034G	Agilent Technologies
Self-resonant frequency	E4991A	Agilent Technologies
DC resistance	Type-7561	Yokogawa

* Equivalent measurement equipment may be used.

MLF series **MLF1005 Type**

■ ELECTRICAL CHARACTERISTICS

□ L FREQUENCY CHARACTERISTICS GRAPH

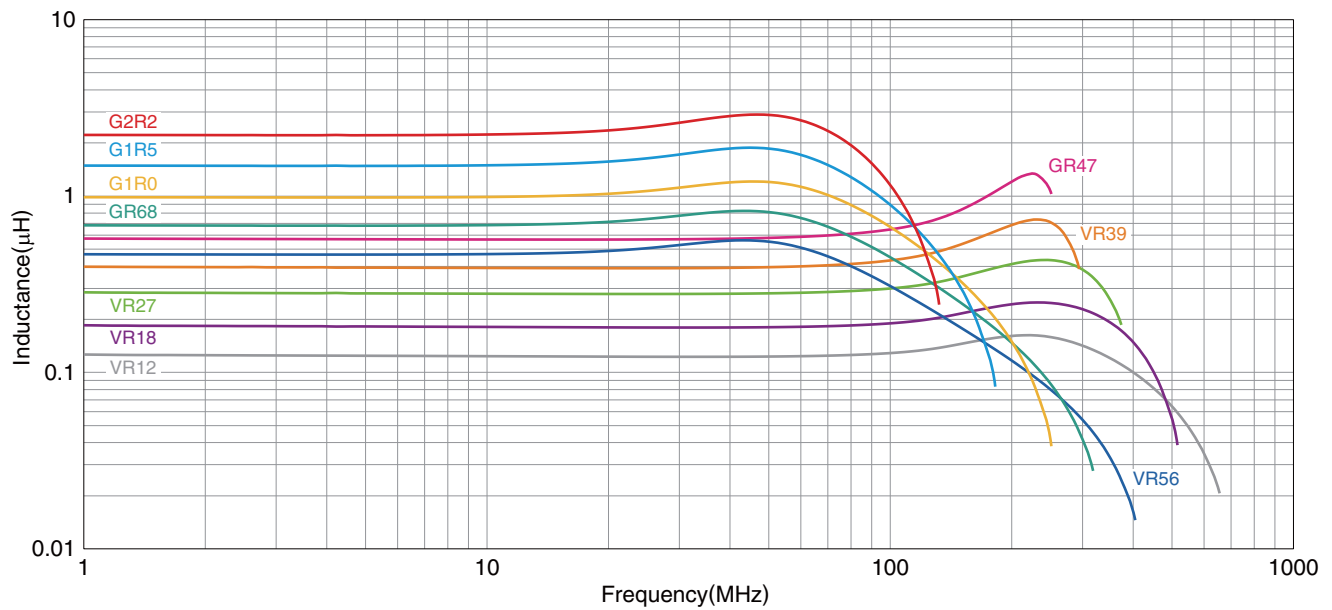
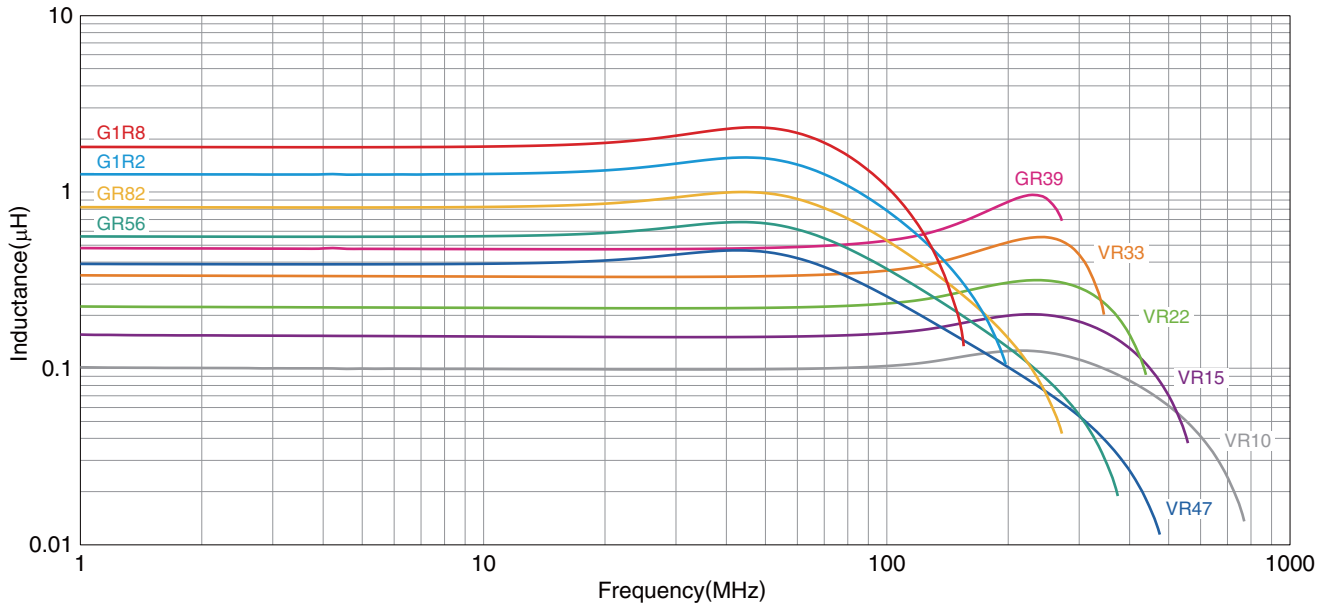

○ Measurement equipment

Product No.	Manufacturer
E4991A+16192A	Agilent Technologies

* Equivalent measurement equipment may be used.

• All specifications are subject to change without notice.

MLF series **MLF1005 Type**

■ ELECTRICAL CHARACTERISTICS

□ Q FREQUENCY CHARACTERISTICS GRAPH

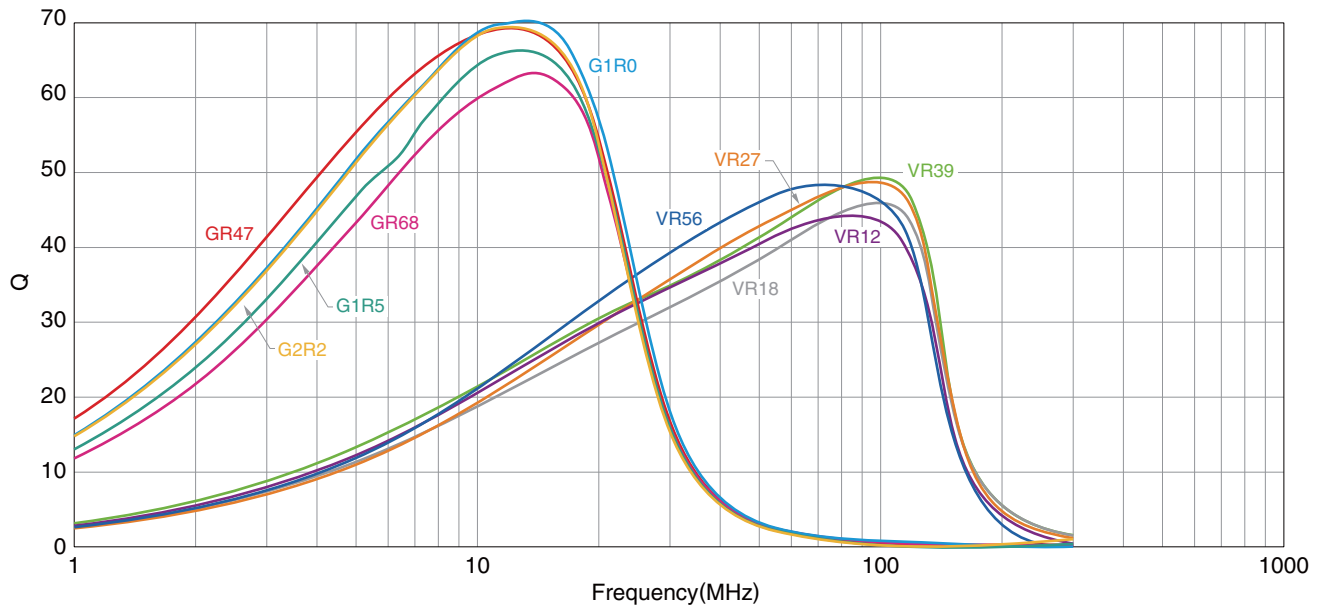
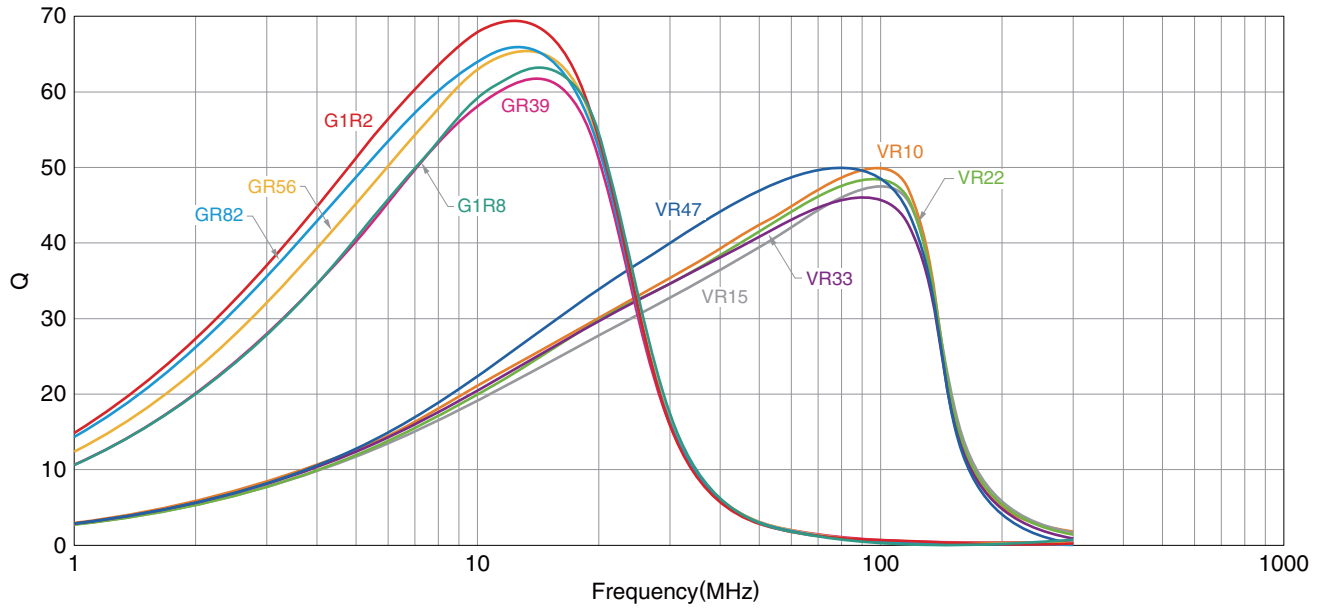

○ Measurement equipment

Product No.	Manufacturer
E4991A+16192A	Agilent Technologies

* Equivalent measurement equipment may be used.

• All specifications are subject to change without notice.

MLF series

MLF1608 Type



■ SHAPE & DIMENSIONS

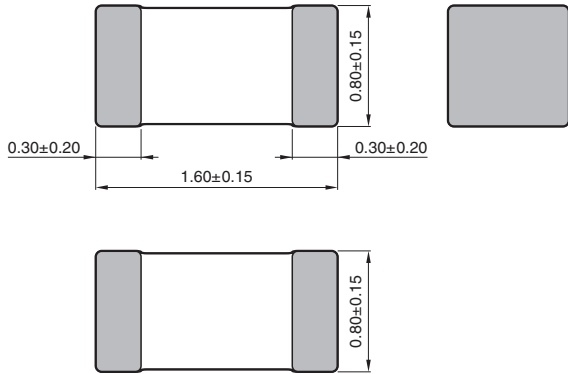

Dimensions in mm

■ RECOMMENDED LAND PATTERN

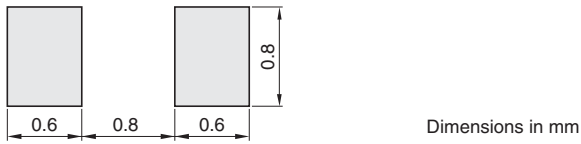

Dimensions in mm

• All specifications are subject to change without notice.

MLF series **MLF1608 Type**

■ ELECTRICAL CHARACTERISTICS

□ CHARACTERISTICS SPECIFICATION TABLE

L (μ H)	Q Tolerance	Q		L, Q measuring conditions		Self-resonant frequency(MHz)		DC resistance (Ω)		Rated current (mA)	Part No.
		min.	typ.	Frequency (MHz)	Current (mA)	min.	typ.	max.	typ.	max.	
0.10	$\pm 5\%$	15	25	25	1.0	450	600	0.35	0.20	200	MLF1608DR10JT000
0.12	$\pm 5\%$	15	25	25	1.0	400	550	0.40	0.20	200	MLF1608DR12JT000
0.15	$\pm 5\%$	15	25	25	1.0	350	500	0.45	0.25	200	MLF1608DR15JT000
0.18	$\pm 5\%$	15	25	25	1.0	320	450	0.50	0.25	150	MLF1608DR18JT000
0.22	$\pm 5\%$	15	25	25	1.0	290	400	0.55	0.30	150	MLF1608DR22JT000
0.27	$\pm 5\%$	15	25	25	1.0	260	350	0.60	0.35	150	MLF1608DR27JT000
0.33	$\pm 5\%$	15	25	25	1.0	230	320	0.75	0.40	100	MLF1608DR33JT000
0.39	$\pm 5\%$	15	25	25	1.0	210	290	0.85	0.45	100	MLF1608DR39JT000
0.47	$\pm 5\%$	15	30	25	1.0	190	260	0.95	0.50	100	MLF1608DR47JT000
0.56	$\pm 5\%$	15	30	25	1.0	170	230	1.05	0.55	100	MLF1608DR56JT000
0.68	$\pm 5\%$	15	30	25	1.0	150	210	1.25	0.65	70	MLF1608DR68JT000
0.82	$\pm 5\%$	15	30	25	1.0	130	190	1.40	0.75	70	MLF1608DR82JT000
1.0	$\pm 5\%$	35	50	10	1.0	120	170	0.50	0.25	50	MLF1608A1R0JT000
1.2	$\pm 5\%$	35	50	10	1.0	110	150	0.65	0.25	50	MLF1608A1R2JT000
1.5	$\pm 5\%$	35	55	10	1.0	100	140	0.70	0.30	50	MLF1608A1R5JT000
1.8	$\pm 5\%$	35	55	10	1.0	90	130	0.85	0.35	50	MLF1608A1R8JT000
2.2	$\pm 5\%$	35	55	10	1.0	80	120	1.00	0.45	30	MLF1608A2R2JT000
2.7	$\pm 5\%$	35	55	10	1.0	70	110	1.15	0.50	30	MLF1608A2R7JT000
3.3	$\pm 5\%$	35	60	10	1.0	65	100	1.30	0.55	30	MLF1608A3R3JT000
3.9	$\pm 5\%$	35	60	10	1.0	60	90	1.45	0.65	30	MLF1608A3R9JT000
4.7	$\pm 5\%$	35	60	10	1.0	55	80	1.60	0.75	30	MLF1608A4R7JT000
5.6	$\pm 5\%$	35	60	4	0.1	45	70	1.10	0.55	15	MLF1608E5R6JT000
6.8	$\pm 5\%$	35	60	4	0.1	40	60	1.30	0.65	15	MLF1608E6R8JT000
8.2	$\pm 5\%$	35	60	4	0.1	35	55	1.50	0.80	10	MLF1608E8R2JT000
10	$\pm 5\%$	30	55	2	0.1	30	50	1.70	1.00	10	MLF1608E100JT000
12	$\pm 5\%$	30	55	2	0.1	25	45	1.80	1.20	10	MLF1608E120JT000
0.10	$\pm 10\%$	15	25	25	1.0	450	600	0.35	0.20	200	MLF1608DR10KTA00
0.12	$\pm 10\%$	15	25	25	1.0	400	550	0.40	0.20	200	MLF1608DR12KTA00
0.15	$\pm 10\%$	15	25	25	1.0	350	500	0.45	0.25	200	MLF1608DR15KTA00
0.18	$\pm 10\%$	15	25	25	1.0	320	450	0.50	0.25	150	MLF1608DR18KTA00
0.22	$\pm 10\%$	15	25	25	1.0	290	400	0.55	0.30	150	MLF1608DR22KTA00
0.27	$\pm 10\%$	15	25	25	1.0	260	350	0.60	0.35	150	MLF1608DR27KTA00
0.33	$\pm 10\%$	15	25	25	1.0	230	320	0.75	0.40	100	MLF1608DR33KTA00
0.39	$\pm 10\%$	15	25	25	1.0	210	290	0.85	0.45	100	MLF1608DR39KTA00
0.47	$\pm 10\%$	15	30	25	1.0	190	260	0.95	0.50	100	MLF1608DR47KTA00
0.56	$\pm 10\%$	15	30	25	1.0	170	230	1.05	0.55	100	MLF1608DR56KTA00
0.68	$\pm 10\%$	15	30	25	1.0	150	210	1.25	0.65	70	MLF1608DR68KTA00
0.82	$\pm 10\%$	15	30	25	1.0	130	190	1.40	0.75	70	MLF1608DR82KTA00
1.0	$\pm 10\%$	35	50	10	1.0	120	170	0.50	0.25	50	MLF1608A1R0KTA00
1.2	$\pm 10\%$	35	50	10	1.0	110	150	0.65	0.25	50	MLF1608A1R2KTA00
1.5	$\pm 10\%$	35	55	10	1.0	100	140	0.70	0.30	50	MLF1608A1R5KTA00
1.8	$\pm 10\%$	35	55	10	1.0	90	130	0.85	0.35	50	MLF1608A1R8KTA00
2.2	$\pm 10\%$	35	55	10	1.0	80	120	1.00	0.45	30	MLF1608A2R2KTA00
2.7	$\pm 10\%$	35	55	10	1.0	70	110	1.15	0.50	30	MLF1608A2R7KTA00
3.3	$\pm 10\%$	35	60	10	1.0	65	100	1.30	0.55	30	MLF1608A3R3KTA00
3.9	$\pm 10\%$	35	60	10	1.0	60	90	1.45	0.65	30	MLF1608A3R9KTA00
4.7	$\pm 10\%$	35	60	10	1.0	55	80	1.60	0.75	30	MLF1608A4R7KTA00

○ Measurement equipment

Measurement item	Product No.	Manufacturer
L, Q	4294A+16034G	Agilent Technologies
Self-resonant frequency	E4991A	Agilent Technologies
DC resistance	Type-7561	Yokogawa

* Equivalent measurement equipment may be used.

• All specifications are subject to change without notice.

MLF series **MLF1608 Type**

■ ELECTRICAL CHARACTERISTICS

□ CHARACTERISTICS SPECIFICATION TABLE

L (μH)	Tolerance	Q		L, Q measuring conditions		Self-resonant frequency(MHz)		DC resistance (Ω)		Rated current (mA)	Part No.
		min.	typ.	Frequency (MHz)	Current (mA)	min.	typ.	max.	typ.	max.	
5.6	$\pm 10\%$	35	60	4	0.1	45	70	1.10	0.55	15	MLF1608E5R6KTA00
6.8	$\pm 10\%$	35	60	4	0.1	40	60	1.30	0.65	15	MLF1608E6R8KTA00
8.2	$\pm 10\%$	35	60	4	0.1	35	55	1.50	0.80	10	MLF1608E8R2KTA00
10	$\pm 10\%$	30	55	2	0.1	30	50	1.70	1.00	10	MLF1608E100KTD00
12	$\pm 10\%$	30	55	2	0.1	25	45	1.80	1.20	10	MLF1608E120KTD00
15	$\pm 10\%$	20	40	1	0.1	22	42	1.50	0.80	2	MLF1608C150KTA00
18	$\pm 10\%$	20	40	1	0.1	20	40	1.60	0.85	2	MLF1608C180KTA00
22	$\pm 10\%$	20	40	1	0.1	18	38	1.70	0.90	2	MLF1608C220KTA00
27	$\pm 10\%$	20	40	1	0.1	15	35	1.80	1.20	2	MLF1608C270KTD00
33	$\pm 10\%$	20	40	1	0.1	10	30	2.20	1.40	2	MLF1608C330KTD00
0.047	$\pm 20\%$	10	20	50	1.0	600	900	0.20	0.10	200	MLF1608D47NMTA00
0.068	$\pm 20\%$	10	20	50	1.0	550	700	0.30	0.15	200	MLF1608D68NMTA00
0.082	$\pm 20\%$	10	20	50	1.0	500	650	0.30	0.15	200	MLF1608D82NMTA00

○ Measurement equipment

Measurement item	Product No.	Manufacturer
L, Q	4294A+16034G	Agilent Technologies
Self-resonant frequency	E4991A	Agilent Technologies
DC resistance	Type-7561	Yokogawa

* Equivalent measurement equipment may be used. **MLF series MLF1608 Type**

ELECTRICAL CHARACTERISTICS

L FREQUENCY CHARACTERISTICS GRAPH

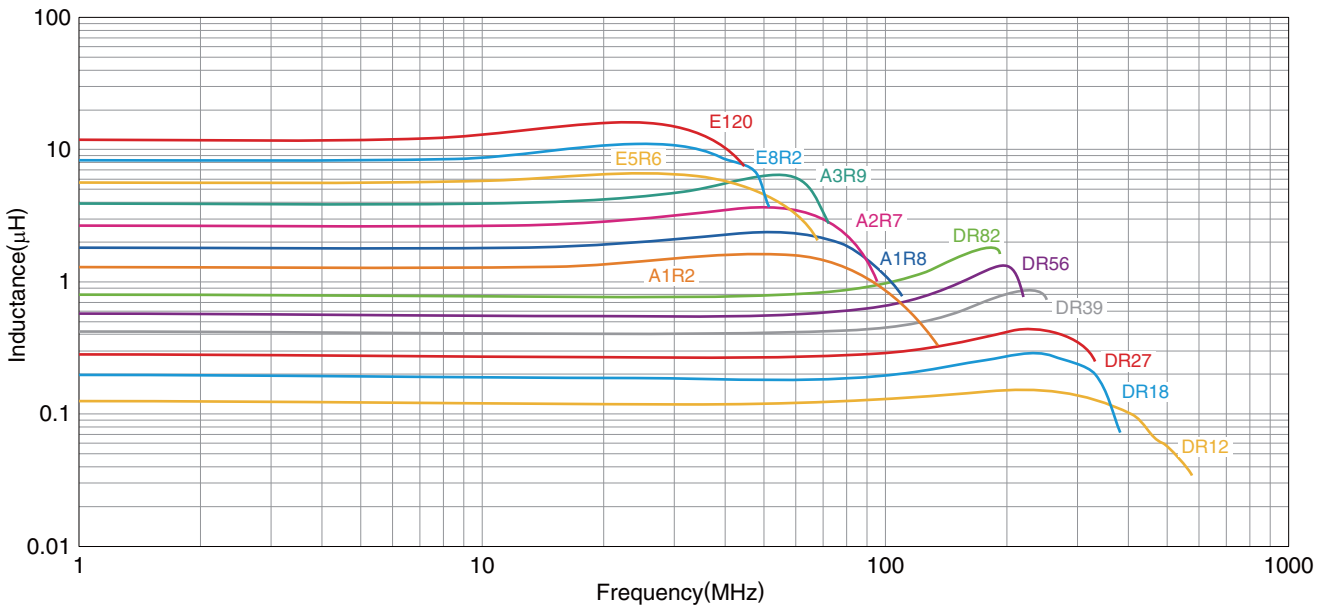
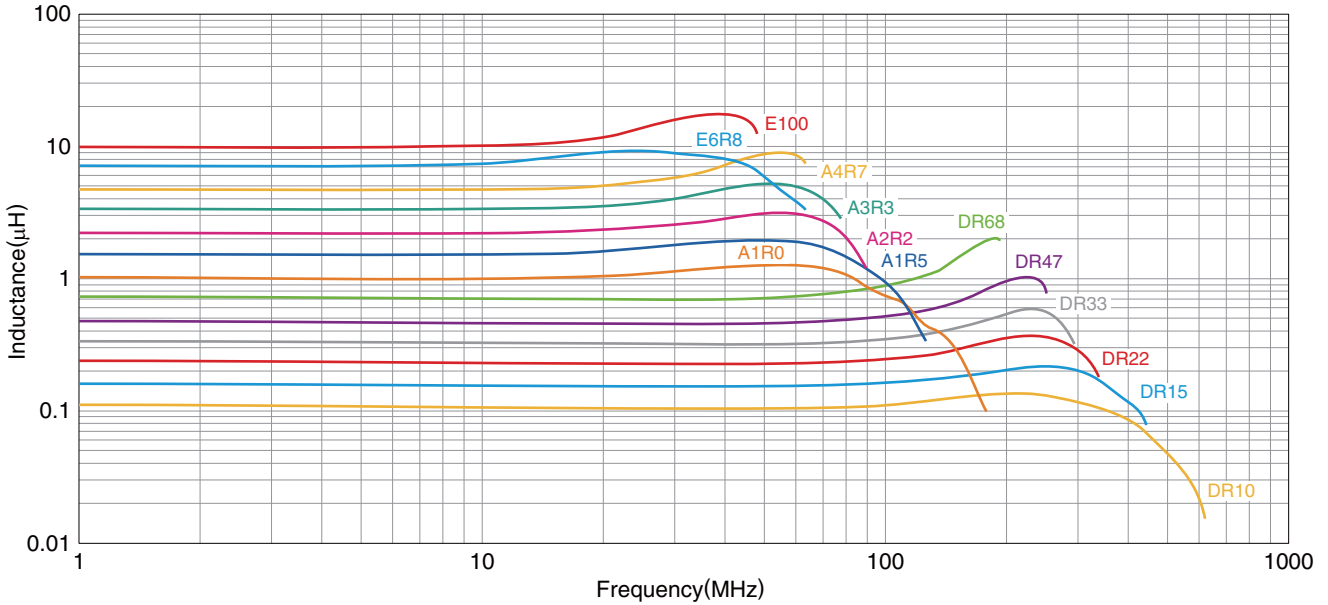

○ Measurement equipment

Product No.	Manufacturer
E4991A+16192A	Agilent Technologies

* Equivalent measurement equipment may be used.

• All specifications are subject to change without notice.

MLF series **MLF1608 Type**

■ ELECTRICAL CHARACTERISTICS

□ L FREQUENCY CHARACTERISTICS GRAPH

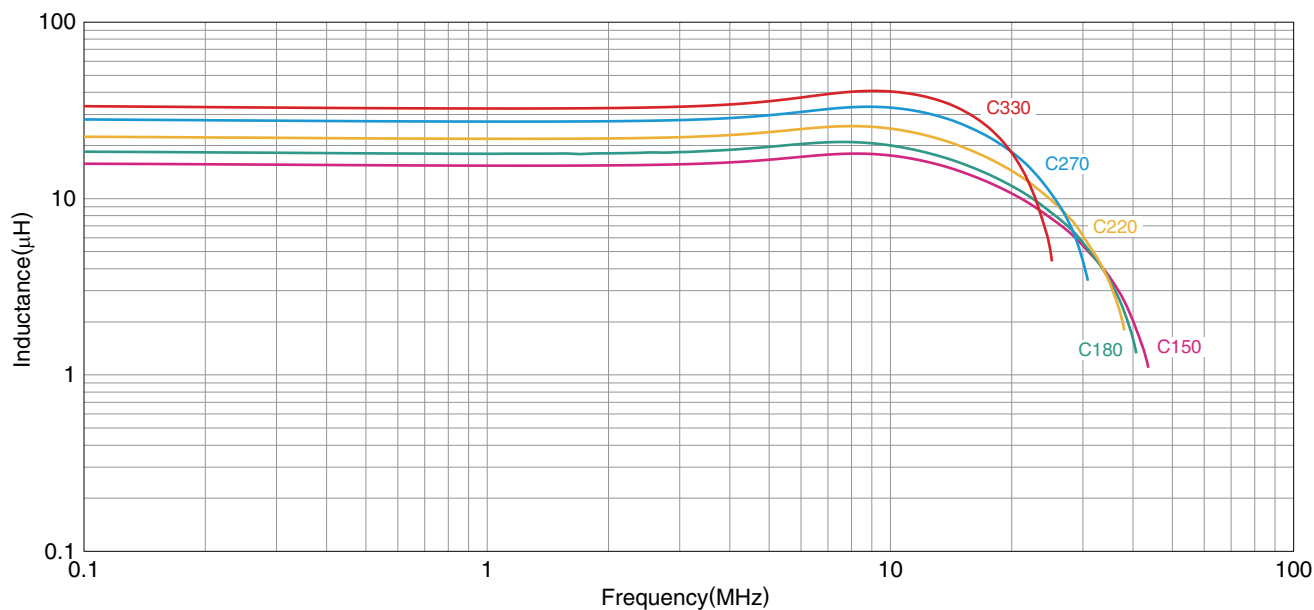

○ Measurement equipment

Product No.	Manufacturer
4294A+16034G	Agilent Technologies

* Equivalent measurement equipment may be used.

MLF series **MLF1608 Type**

■ ELECTRICAL CHARACTERISTICS

□ Q FREQUENCY CHARACTERISTICS GRAPH

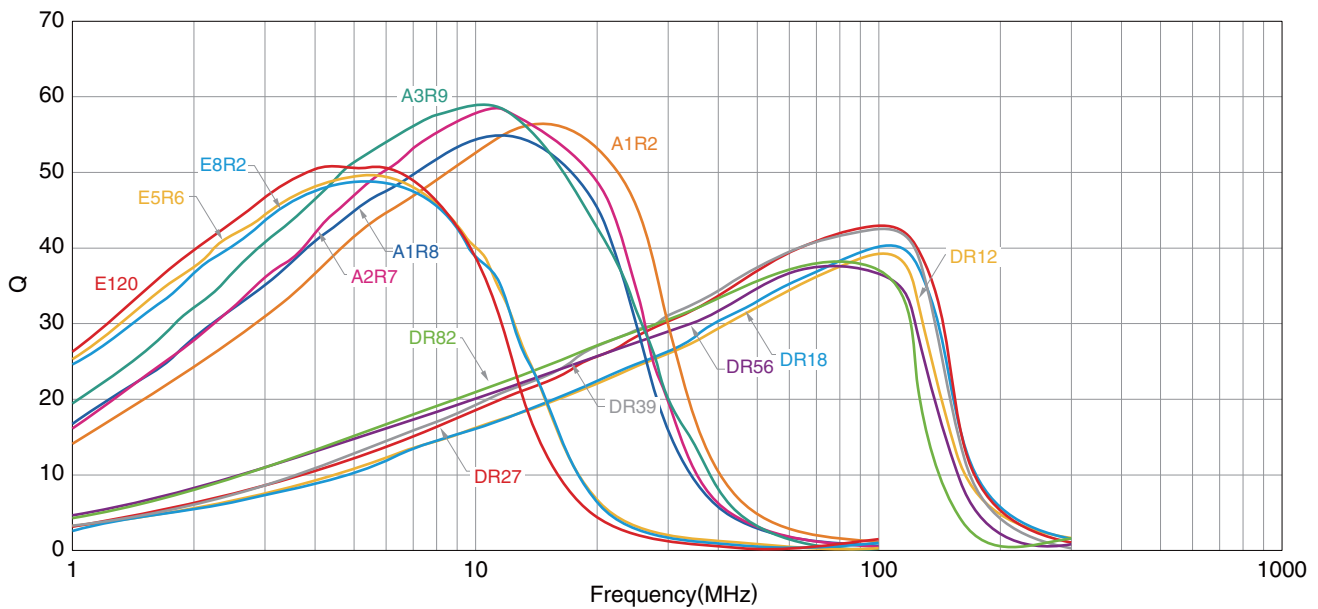
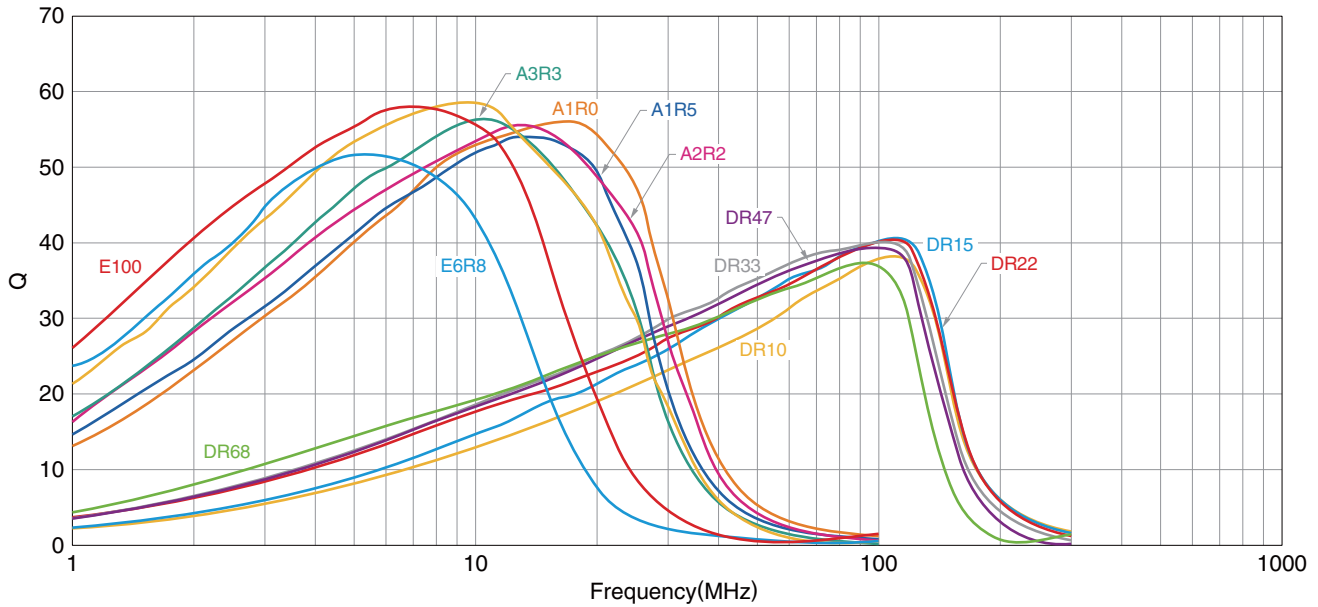

○ Measurement equipment

Product No.	Manufacturer
E4991A+16192A	Agilent Technologies

* Equivalent measurement equipment may be used.

• All specifications are subject to change without notice.

MLF series **MLF1608 Type**

■ ELECTRICAL CHARACTERISTICS

□ Q FREQUENCY CHARACTERISTICS GRAPH

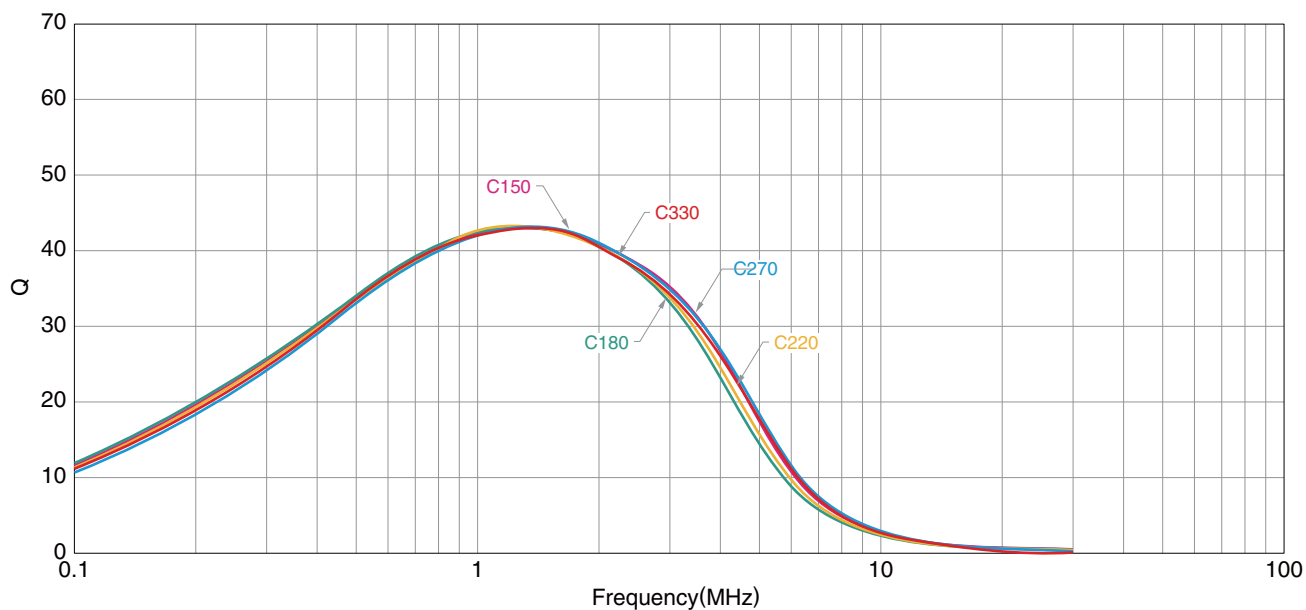

○ Measurement equipment

Product No.	Manufacturer
4294A+16034G	Agilent Technologies

* Equivalent measurement equipment may be used.

MLF series

MLF2012 Type



■ SHAPE & DIMENSIONS

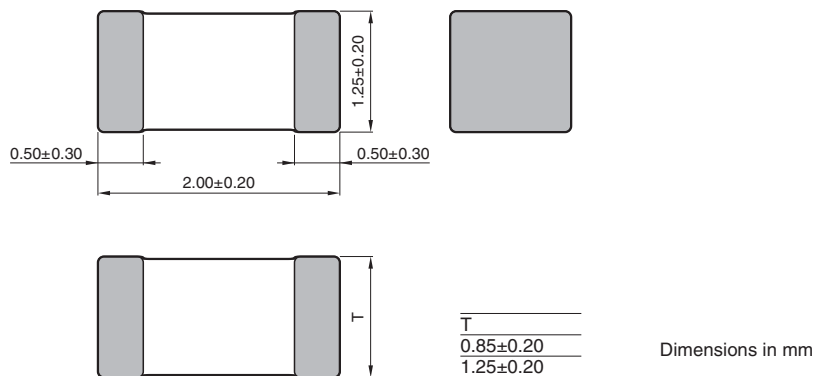

■ RECOMMENDED LAND PATTERN

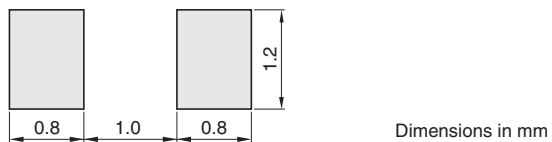

• All specifications are subject to change without notice.

MLF series **MLF2012 Type**

■ ELECTRICAL CHARACTERISTICS

□ CHARACTERISTICS SPECIFICATION TABLE

L (μ H)	Q Tolerance	Q		L, Q measuring conditions		Self-resonant frequency(MHz)		DC resistance (Ω)		Rated current (mA)	Thickness T (mm)	Part No.
		min.	typ.	Frequency (MHz)	Current (mA)	min.	typ.	max.	typ.	max.		
0.10	$\pm 5\%$	20	30	25	1.0	400	500	0.15	0.10	300	0.85	MLF2012DR10JT000
0.12	$\pm 5\%$	20	30	25	1.0	360	450	0.20	0.12	300	0.85	MLF2012DR12JT000
0.15	$\pm 5\%$	20	30	25	1.0	320	410	0.20	0.13	300	0.85	MLF2012DR15JT000
0.18	$\pm 5\%$	20	30	25	1.0	280	370	0.25	0.15	300	0.85	MLF2012DR18JT000
0.22	$\pm 5\%$	20	30	25	1.0	250	330	0.30	0.16	250	0.85	MLF2012DR22JT000
0.27	$\pm 5\%$	20	30	25	1.0	220	300	0.35	0.18	250	0.85	MLF2012DR27JT000
0.33	$\pm 5\%$	20	30	25	1.0	200	270	0.40	0.23	250	0.85	MLF2012DR33JT000
0.39	$\pm 5\%$	25	35	25	1.0	180	250	0.45	0.25	200	0.85	MLF2012DR39JT000
0.47	$\pm 5\%$	25	35	25	1.0	160	230	0.50	0.25	200	1.25	MLF2012DR47JT000
0.56	$\pm 5\%$	25	35	25	1.0	150	210	0.55	0.30	150	1.25	MLF2012DR56JT000
0.68	$\pm 5\%$	25	35	25	1.0	140	190	0.60	0.35	150	1.25	MLF2012DR68JT000
0.82	$\pm 5\%$	25	35	25	1.0	130	170	0.65	0.40	150	1.25	MLF2012DR82JT000
1.0	$\pm 5\%$	45	55	10	1.0	120	160	0.30	0.15	80	0.85	MLF2012A1R0JT000
1.2	$\pm 5\%$	45	55	10	1.0	110	150	0.35	0.15	80	0.85	MLF2012A1R2JT000
1.5	$\pm 5\%$	45	60	10	1.0	100	140	0.40	0.18	80	0.85	MLF2012A1R5JT000
1.8	$\pm 5\%$	45	60	10	1.0	90	130	0.45	0.20	80	0.85	MLF2012A1R8JT000
2.2	$\pm 5\%$	45	60	10	1.0	80	120	0.50	0.22	50	0.85	MLF2012A2R2JT000
2.7	$\pm 5\%$	45	70	10	1.0	70	100	0.55	0.25	50	1.25	MLF2012A2R7JT000
3.3	$\pm 5\%$	45	70	10	1.0	60	90	0.60	0.28	50	1.25	MLF2012A3R3JT000
3.9	$\pm 5\%$	45	70	10	1.0	55	80	0.65	0.30	30	1.25	MLF2012A3R9JT000
4.7	$\pm 5\%$	45	70	10	1.0	50	70	0.70	0.35	30	1.25	MLF2012A4R7JT000
5.6	$\pm 5\%$	50	75	4	1.0	45	65	0.60	0.30	15	1.25	MLF2012E5R6JT000
6.8	$\pm 5\%$	50	75	4	0.1	40	60	0.65	0.32	15	1.25	MLF2012E6R8JT000
8.2	$\pm 5\%$	50	75	4	0.1	35	55	0.70	0.35	15	1.25	MLF2012E8R2JT000
10	$\pm 5\%$	50	75	2	0.1	30	50	0.80	0.40	15	1.25	MLF2012E100JT000
12	$\pm 5\%$	50	75	2	0.1	25	45	0.90	0.50	15	1.25	MLF2012E120JT000
0.10	$\pm 10\%$	20	30	25	1.0	400	500	0.15	0.10	300	0.85	MLF2012DR10KT000
0.12	$\pm 10\%$	20	30	25	1.0	360	450	0.20	0.12	300	0.85	MLF2012DR12KT000
0.15	$\pm 10\%$	20	30	25	1.0	320	410	0.20	0.13	300	0.85	MLF2012DR15KT000
0.18	$\pm 10\%$	20	30	25	1.0	280	370	0.25	0.15	300	0.85	MLF2012DR18KT000
0.22	$\pm 10\%$	20	30	25	1.0	250	330	0.30	0.16	250	0.85	MLF2012DR22KT000
0.27	$\pm 10\%$	20	30	25	1.0	220	300	0.35	0.18	250	0.85	MLF2012DR27KT000
0.33	$\pm 10\%$	20	30	25	1.0	200	270	0.40	0.23	250	0.85	MLF2012DR33KT000
0.39	$\pm 10\%$	25	35	25	1.0	180	250	0.45	0.25	200	0.85	MLF2012DR39KT000
0.47	$\pm 10\%$	25	35	25	1.0	160	230	0.50	0.25	200	1.25	MLF2012DR47KT000
0.56	$\pm 10\%$	25	35	25	1.0	150	210	0.55	0.30	150	1.25	MLF2012DR56KT000
0.68	$\pm 10\%$	25	35	25	1.0	140	190	0.60	0.35	150	1.25	MLF2012DR68KT000
0.82	$\pm 10\%$	25	35	25	1.0	130	170	0.65	0.40	150	1.25	MLF2012DR82KT000
1.0	$\pm 10\%$	45	55	10	1.0	120	160	0.30	0.15	80	0.85	MLF2012A1R0KT000
1.2	$\pm 10\%$	45	55	10	1.0	110	150	0.35	0.15	80	0.85	MLF2012A1R2KT000
1.5	$\pm 10\%$	45	60	10	1.0	100	140	0.40	0.18	80	0.85	MLF2012A1R5KT000
1.8	$\pm 10\%$	45	60	10	1.0	90	130	0.45	0.20	80	0.85	MLF2012A1R8KT000
2.2	$\pm 10\%$	45	60	10	1.0	80	120	0.50	0.22	50	0.85	MLF2012A2R2KT000
2.7	$\pm 10\%$	45	70	10	1.0	70	100	0.55	0.25	50	1.25	MLF2012A2R7KT000
3.3	$\pm 10\%$	45	70	10	1.0	60	90	0.60	0.28	50	1.25	MLF2012A3R3KT000
3.9	$\pm 10\%$	45	70	10	1.0	55	80	0.65	0.30	30	1.25	MLF2012A3R9KT000
4.7	$\pm 10\%$	45	70	10	1.0	50	70	0.70	0.35	30	1.25	MLF2012A4R7KT000

○ Measurement equipment

Measurement item	Product No.	Manufacturer
L, Q	4294A+16034G	Agilent Technologies
Self-resonant frequency	E4991A	Agilent Technologies
DC resistance	Type-7561	Yokogawa

* Equivalent measurement equipment may be used.

MLF series **MLF2012 Type**

■ ELECTRICAL CHARACTERISTICS

□ CHARACTERISTICS SPECIFICATION TABLE

L (μH)	Q Tolerance	Q		L, Q measuring conditions		Self-resonant frequency(MHz)		DC resistance (Ω)		Rated current (mA)	Thickness T (mm)	Part No.
		min.	typ.	Frequency (MHz)	Current (mA)	min.	typ.	max.	typ.	max.		
5.6	$\pm 10\%$	50	75	4	0.1	45	65	0.60	0.30	15	1.25	MLF2012E5R6KT000
6.8	$\pm 10\%$	50	75	4	0.1	40	60	0.65	0.32	15	1.25	MLF2012E6R8KT000
8.2	$\pm 10\%$	50	75	4	0.1	35	55	0.70	0.35	15	1.25	MLF2012E8R2KT000
10	$\pm 10\%$	50	75	2	0.1	30	50	0.80	0.40	15	1.25	MLF2012E100KT000
12	$\pm 10\%$	50	75	2	0.1	25	45	0.90	0.50	15	1.25	MLF2012E120KT000
15	$\pm 10\%$	30	45	1	0.1	22	40	0.70	0.35	5	1.25	MLF2012C150KT000
18	$\pm 10\%$	30	45	1	0.1	20	38	0.80	0.38	5	1.25	MLF2012C180KT000
22	$\pm 10\%$	30	45	1	0.1	18	35	0.90	0.45	5	1.25	MLF2012C220KT000
27	$\pm 10\%$	30	45	1	0.1	17	33	1.00	0.50	5	1.25	MLF2012C270KT000
33	$\pm 10\%$	30	45	0.4	0.1	15	28	1.10	0.55	5	1.25	MLF2012C330KT000
39	$\pm 10\%$	35	55	2	0.1	13	23	2.40	1.30	4	1.25	MLF2012K390KT000
47	$\pm 10\%$	35	55	2	0.1	11	20	2.70	1.60	4	1.25	MLF2012K470KT000
56	$\pm 10\%$	35	55	2	0.1	10	18	2.80	1.80	4	1.25	MLF2012K560KT000
68	$\pm 10\%$	25	45	1	0.1	9	16	2.90	2.00	2	1.25	MLF2012C680KT000
82	$\pm 10\%$	25	45	1	0.1	8	14	3.00	2.40	2	1.25	MLF2012C820KT000
100	$\pm 10\%$	25	45	1	0.1	7	12	3.10	2.50	2	1.25	MLF2012C101KT000
0.047	$\pm 20\%$	15	25	50	1.0	550	700	0.10	0.05	300	0.85	MLF2012D47NMT000
0.068	$\pm 20\%$	15	25	50	1.0	500	600	0.15	0.08	300	0.85	MLF2012D68NMT000
0.082	$\pm 20\%$	15	25	50	1.0	450	550	0.15	0.08	300	0.85	MLF2012D82NMT000

○ Measurement equipment

Measurement item	Product No.	Manufacturer
L, Q	4294A+16034G	Agilent Technologies
Self-resonant frequency	E4991A	Agilent Technologies
DC resistance	Type-7561	Yokogawa

* Equivalent measurement equipment may be used.

MLF series **MLF2012 Type**

■ ELECTRICAL CHARACTERISTICS

□ L FREQUENCY CHARACTERISTICS GRAPH

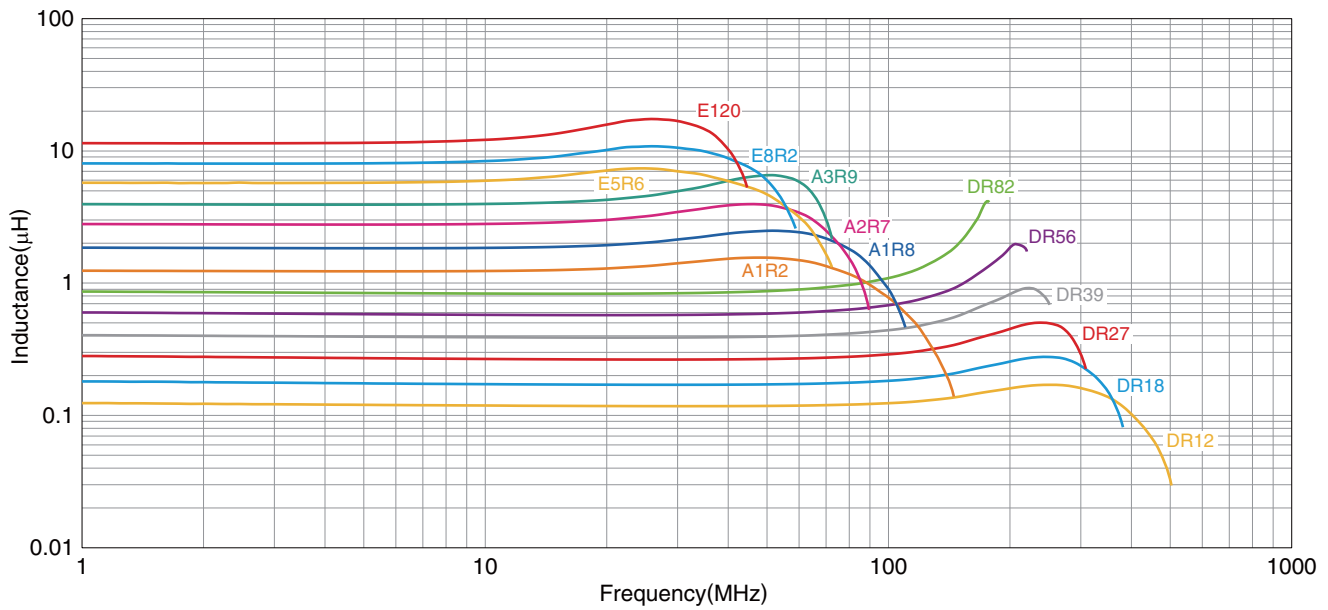
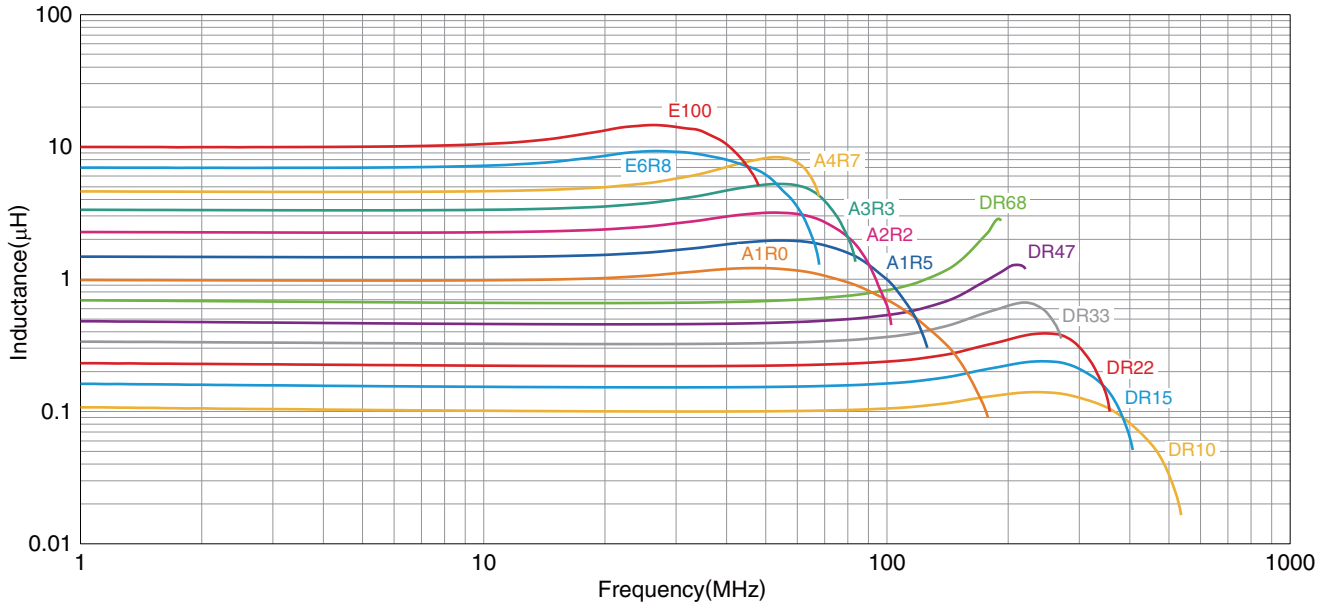

○ Measurement equipment

Product No.	Manufacturer
E4991A+16192A	Agilent Technologies

* Equivalent measurement equipment may be used.

• All specifications are subject to change without notice.

MLF series **MLF2012 Type**

■ ELECTRICAL CHARACTERISTICS

□ L FREQUENCY CHARACTERISTICS GRAPH

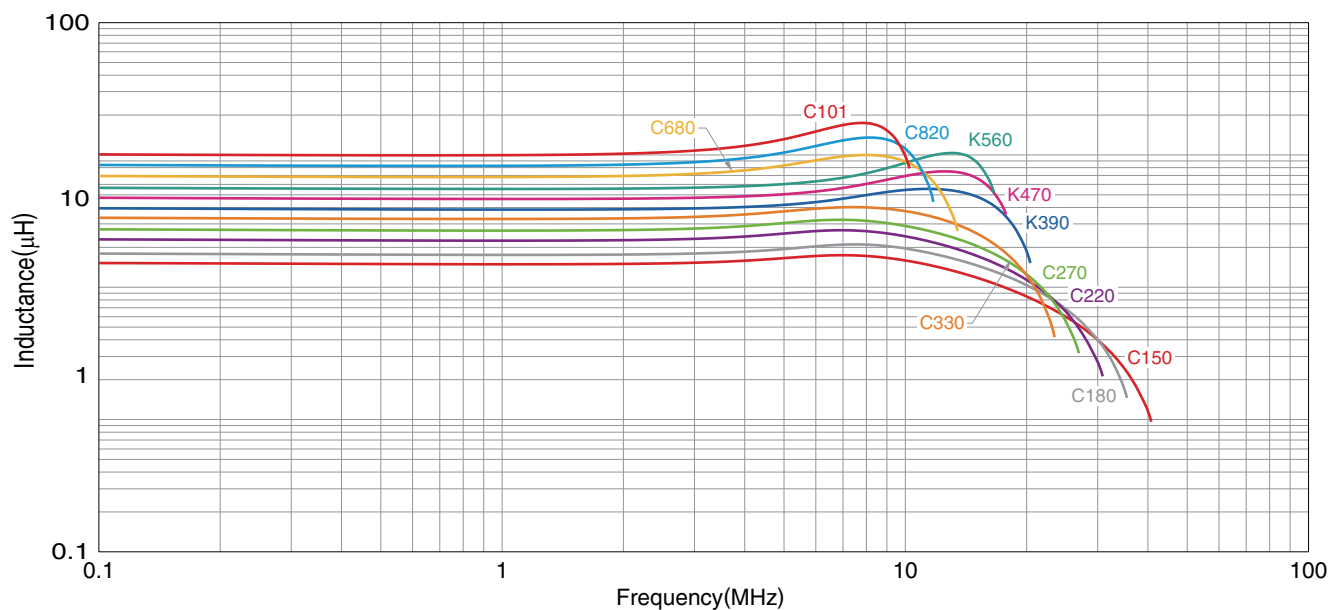

○ Measurement equipment

Product No.	Manufacturer
4294A+16034G	Agilent Technologies

* Equivalent measurement equipment may be used.

• All specifications are subject to change without notice.

MLF series MLF2012 Type

ELECTRICAL CHARACTERISTICS

Q FREQUENCY CHARACTERISTICS GRAPH

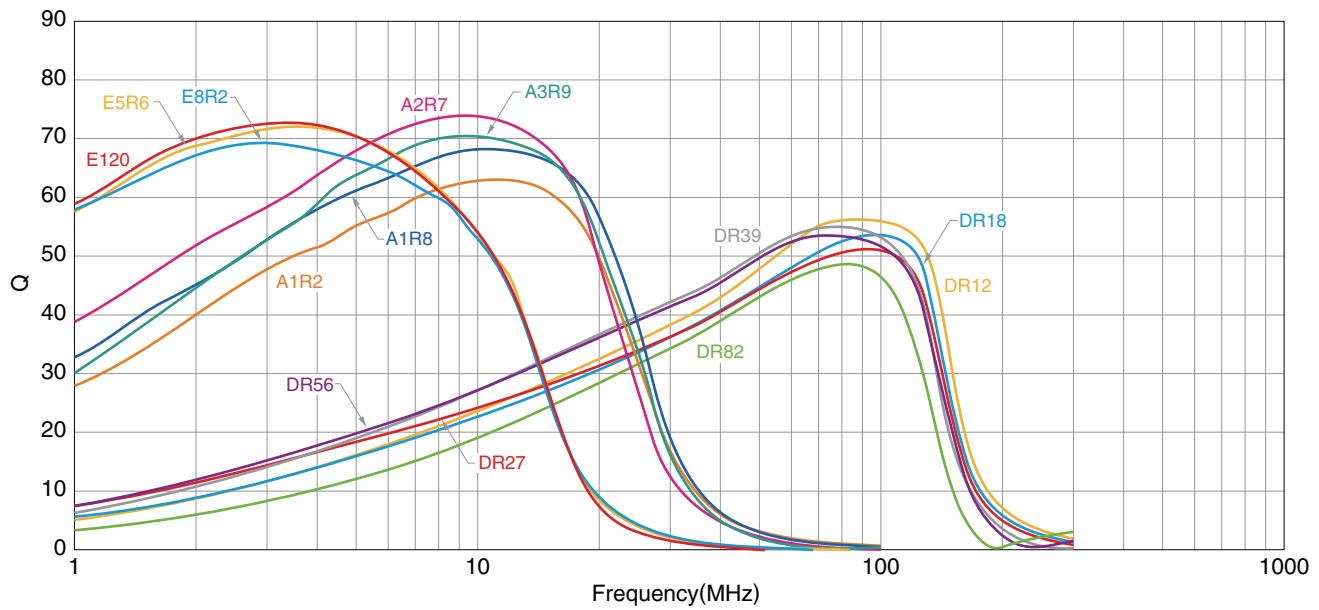
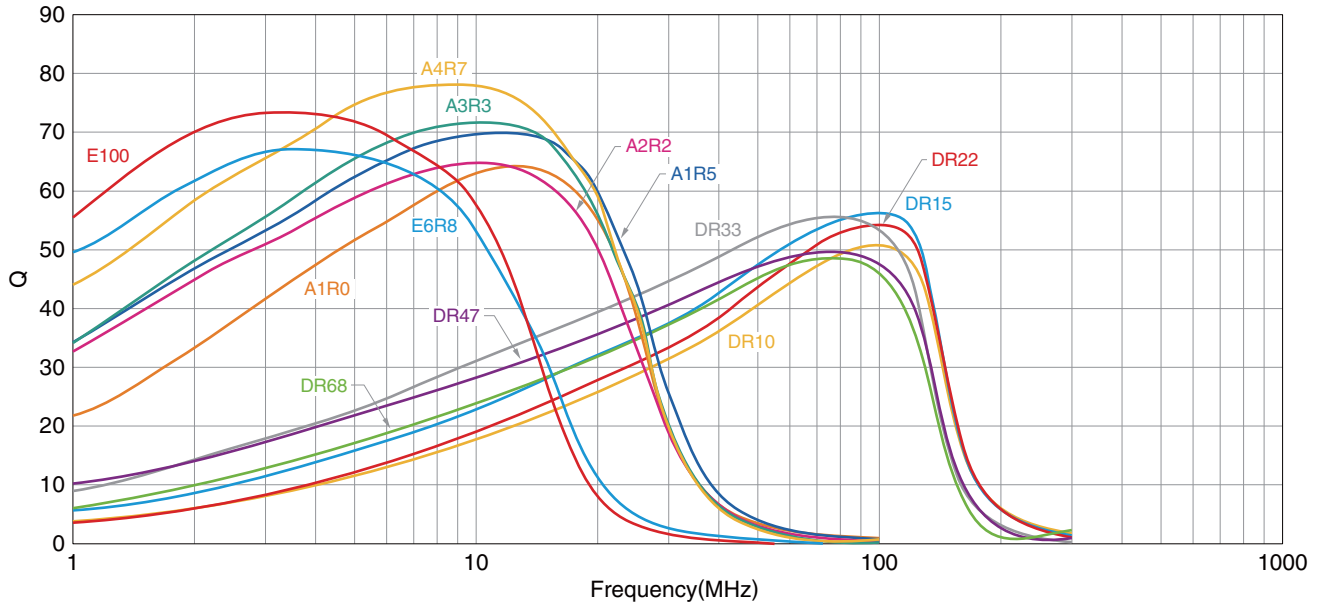

○ Measurement equipment

Product No.	Manufacturer
E4991A+16192A	Agilent Technologies

* Equivalent measurement equipment may be used.

• All specifications are subject to change without notice.

MLF series **MLF2012 Type**

Q FREQUENCY CHARACTERISTICS GRAPH

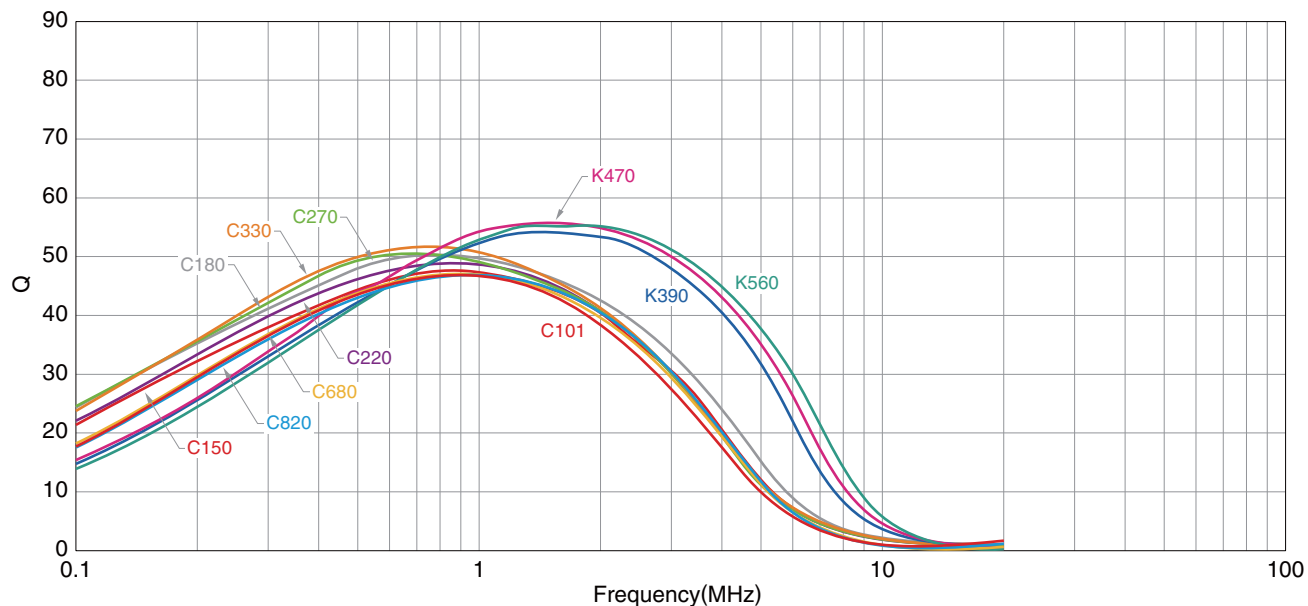

○ Measurement equipment

Product No.	Manufacturer
4294A+16034G	Agilent Technologies

* Equivalent measurement equipment may be used.

• All specifications are subject to change without notice.

MLF series

Packaging Style

REEL DIMENSIONS

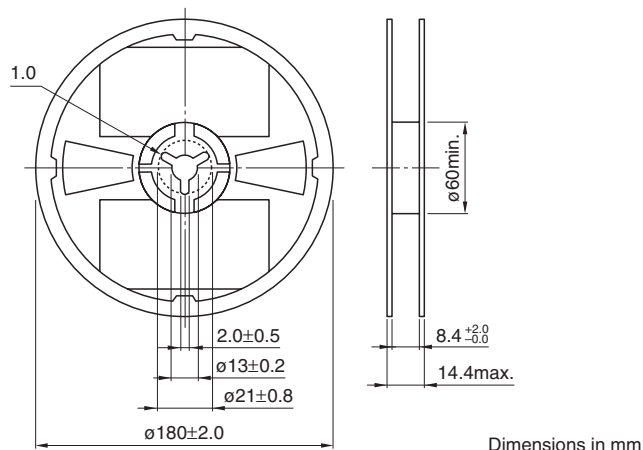

Dimensions in mm

TAPE DIMENSIONS

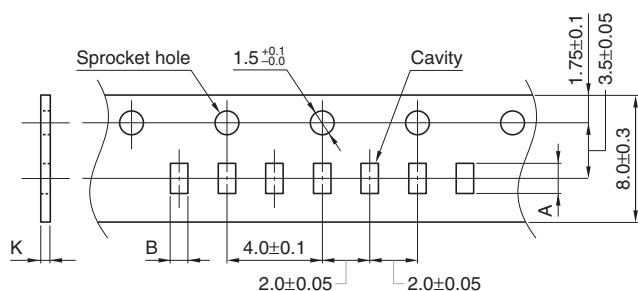

Type	A	B	K
MLF1005	1.15 ± 0.1	0.65 ± 0.1	0.8 max.
MLF1608	1.9 ± 0.2	1.1 ± 0.2	1.1 max.
MLF2012	t=0.85	2.3 ± 0.2	1.5 ± 0.2
	t=1.25	2.3 ± 0.2	1.5 ± 0.2

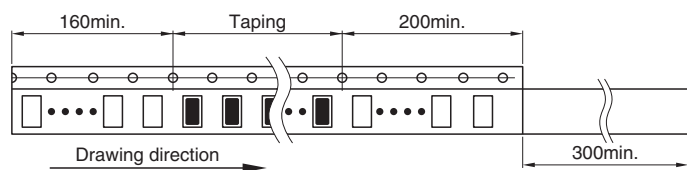

Dimensions in mm

• All specifications are subject to change without notice.