

DOREXS



ОБРАЗЦЫ ЭМИ ФИЛЬТРОВ ПОД ВАШ ПРОЕКТ

Заказать образцы, запросить документацию и задать все интересующие вопросы, связанные с применением ЭМИ фильтров, Вы можете нашим техническим специалистам и менеджерам:

e-mail: epcos@ferrite.ru

тел.: +7 (812) 740 53 05, +7 (812) 740 53 06



A Series

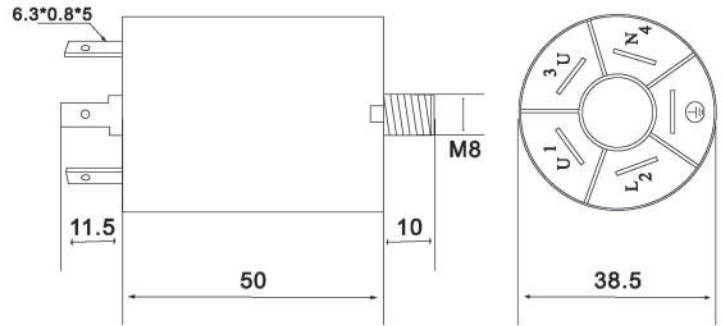
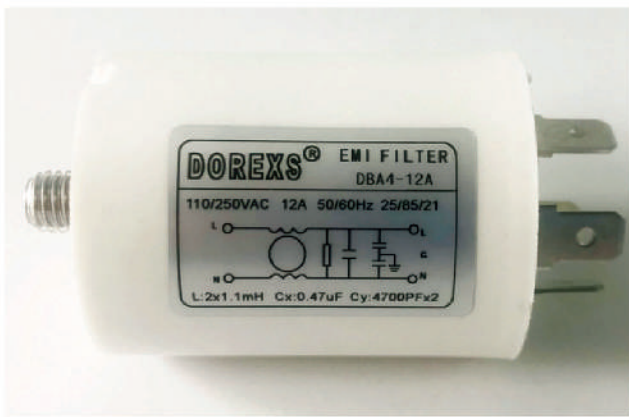

Outline Drawing and Dimensions ($\pm 0.5\text{mm}$)

Features

- Single Phase AC Filters
- General purpose
- Filter with a good suppression to common-mode and differential-mode interference

Applications

- Apply to various of home appliance: washing machine, refrigerator, microwave oven, etc.

Technical Data

Rated Voltage	115/250VAC
Line Frequency	50/60Hz
Test Voltage	1500VDC (line/line) 1500VAC (line/ground)
Insulation Resistance	> 50M Ω @500VDC
Temperature Rise	< 30 $^{\circ}\text{C}$
Climatic category	25/085/21

List of general products

Part No.	Rated Current	Leakage Current	Dimension	Electrical Schematics
DBA4-10A	10A	<0.5mA	A4	
DBA4-12A	12A	<0.5mA	A4	
DBA4-16A	16A	<0.5mA	A4	

Insertion Loss

(Common Mode)

(Differential Mode)

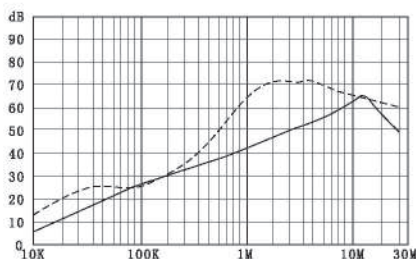

DBA4-10A

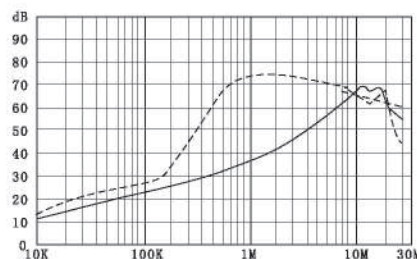

DBA4-12A

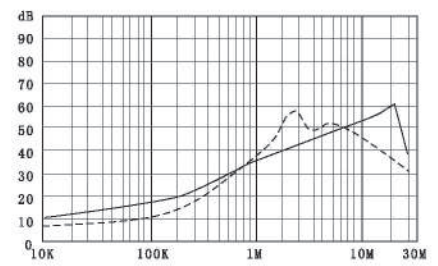

DBA4-16A

A Series

Features



- Single Phase AC Filters
- General purpose
- Filter with a good suppression to common-mode and differential-mode interference

Applications

- Available for mini-electronic equipments and electronic measuring instruments

Technical Data

Rated Voltage	115/250VAC
Line Frequency	50/60Hz
Test Voltage	1500VDC (line/line) 1500VAC (line/ground)
Insulation Resistance	> 50M Ω @500VDC
Temperature Rise	< 30 $^{\circ}$ C
Climatic category	25/085/21

List of general products

Part No.	Rated Current	Leakage Current	Dimension	Terminal		Electrical Schematics
				Input	Output	
DAA1-1A	1A	<0.5mA	A1			<p style="text-align: right;">A</p>
DAA1-3A	3A	<0.5mA	A1			
DAA1-6A	6A	<0.5mA	A1			
DAA2-10A	10A	<0.5mA	A2			
DBA3-6A	6A	<1.0mA	A3			<p style="text-align: right;">B</p>
DBA3-10A	10A	<1.0mA	A3			
DBA4-20A	20A	<1.0mA	A4			
DBA4-30A	30A	<1.0mA	A4			
DBA5-20A/30A	20A/30A	<1.0mA	A5			
DBA7-50A	50A	<2.0mA	A6			
DBA7-100A	100A	<2.0mA	A7			

Outline Drawing and Dinensions(mm)

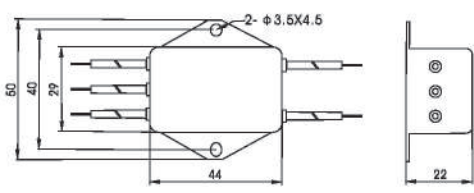

A1

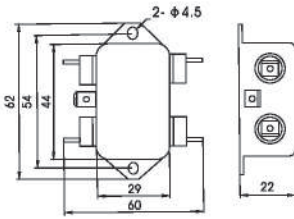

A2

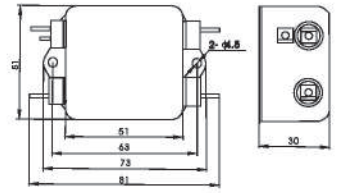

A3

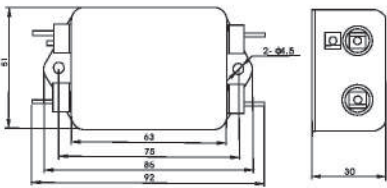

A4

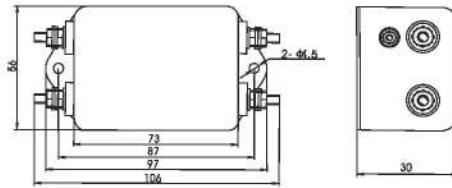

A5

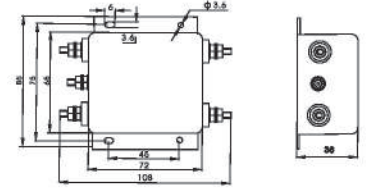

A6

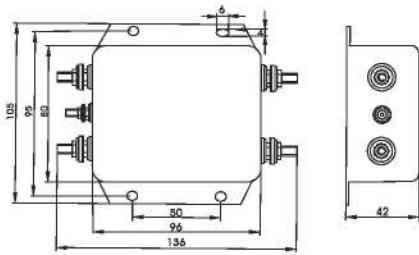

A7

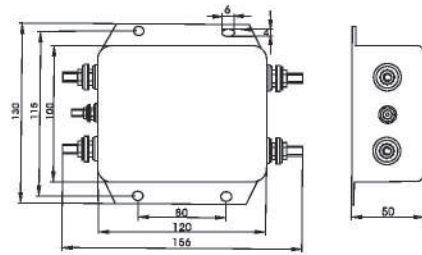

A8

Insertion Loss

———— (Common Mode)

----- (Differential Mode)

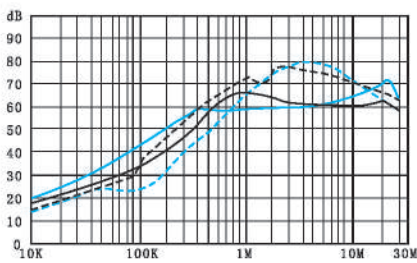

DAA1-1A, DAA1-3A

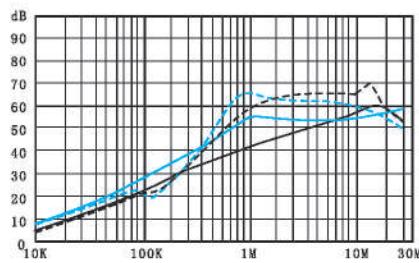

DAA1-6A, DAA2-10A

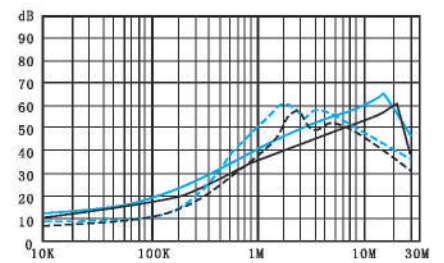

DBA3-6A, DBA3-10A

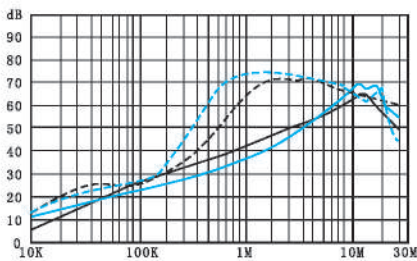

DBA4-20A, DBA5-30A

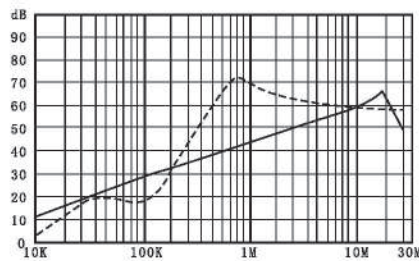

DBA7-50A

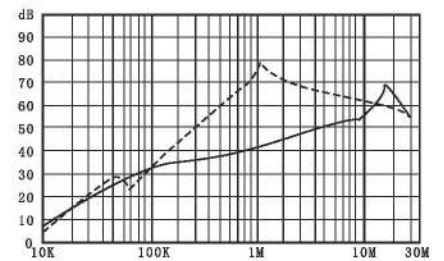

DBA8-100A

B Series

Features



- Single Phase AC Filters
- With differential mode choke
- Available for Single-Chip computer systems and

Applications

- Switching power supplies

Technical Data

Rated Voltage	115/250VAC
Line Frequency	50/60Hz
Test Voltage	1500VDC (line/line) 1500VAC (line/ground)
Insulation Resistance	> 50MΩ@500VDC
Temperature Rise	< 30°C
Climatic category	25/085/21

List of general products

Part No.	Rated Current	Leakage Current	Dimension	Terminal		Electrical Schematics
				Input	Output	
DCA1-1A	1A	<0.5mA	A1			
DCB1-3A	3A	<0.5mA	B1			
DCB1-6A	6A	<1.0mA	B1			
DCA4-10A	10A	<1.0mA	A4			
DCA7-20A	20A	<1.0mA	A7			
DCB2-50A	50A	<2.0mA	B2			
DCB3-100A	100A	<3.0mA	B3			
DCB4-200A	200A	<3.0mA	B4			

Outline Drawing and Dinemnsions(mm)

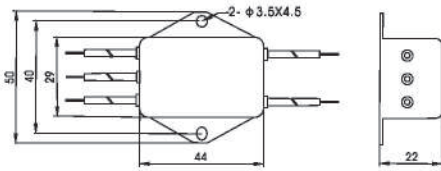

A1

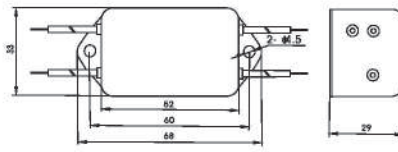

B1

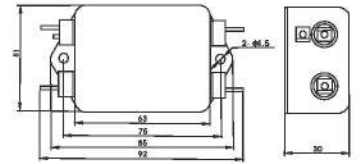

A4

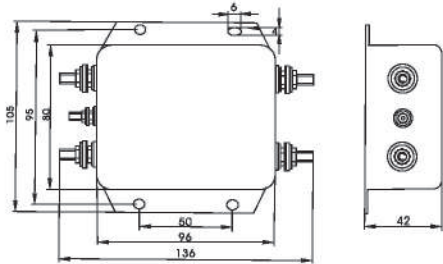

A7

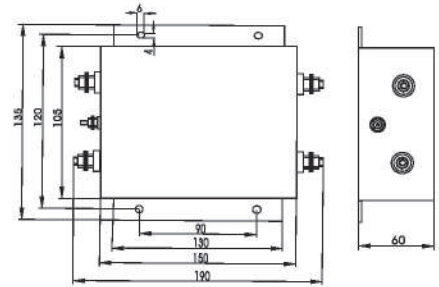

B2

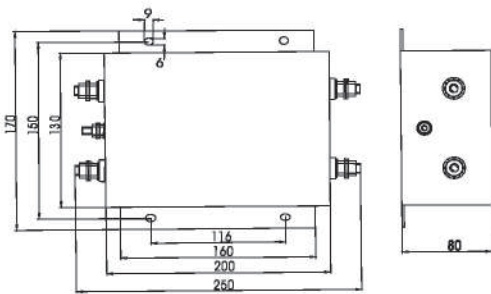

B3

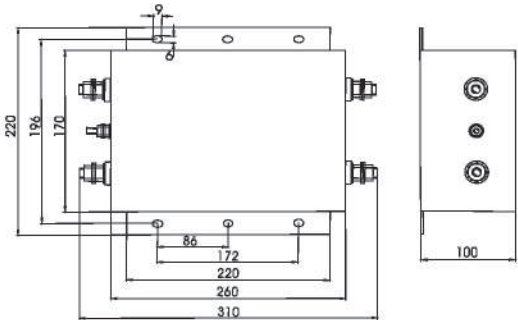

B4

Insertion Loss

———— (Common Mode)

----- (Differential Mode)

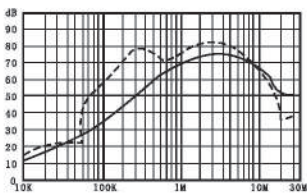

DCA1-1A

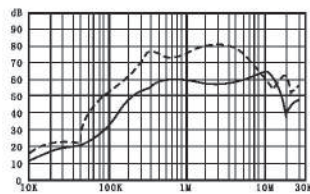

DCB1-3A

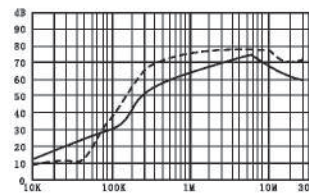

DCB1-6A

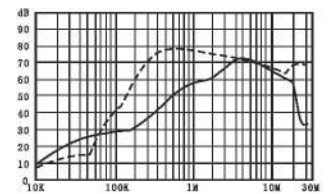

DCA4-10A

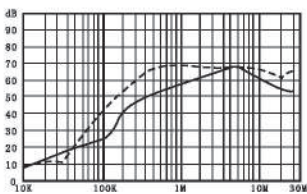

DCA7-20A

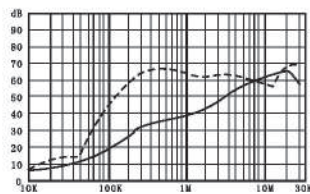

DCB2-50A

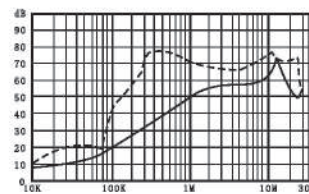

DCB3-100A

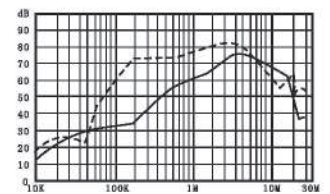

DCB4-200A

B Series

Features



- Single Phase AC Filters
- High performance Filters
- Good performance of common mode and differential mode interference suppression

Applications

- Available for Single-Chip computer systems and switching power supplies

Technical Data

Rated Voltage	115/250VAC
Line Frequency	50/60Hz
Test Voltage	1500VDC (line/line) 1500VAC (line/ground)
Insulation Resistance	> 50M Ω @500VDC
Temperature Rise	< 30 $^{\circ}$ C
Climatic category	25/085/21

List of general products

Part No.	Rated Current	Leakage Current	Dimension	Terminal		Electrical Schematic
				Input	Output	
DDA1-1A	1A	<0.5mA	A1			
DDB1-3A	3A	<0.5mA	B1			
DDB1-6A	6A	<0.5mA	B1			
DDA4-10A	10A	<0.5mA	A4			
DEA1-1A	1A	<1.0mA	A1			
DEB1-3A	3A	<1.0mA	B1			
DEB1-6A	6A	<1.0mA	B1			
DEA4-6A	6A	<1.0mA	A4			
DEA4-10A	10A	<1.0mA	A4			
DEA5-20A	20A	<1.0mA	A5			
DEB2-50A	50A	<2.0mA	B2			
DEB3-100A	100A	<2.0mA	B3			

Outline Drawing and Dinensions(mm)

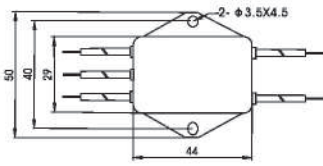

A1

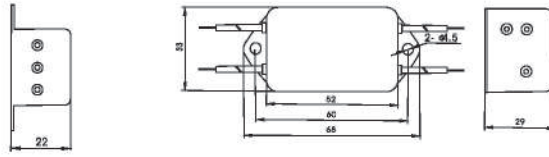

B1

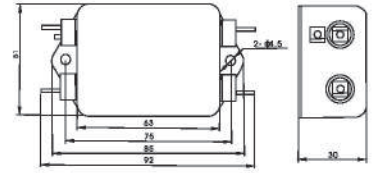

A4

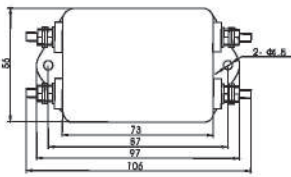

A5

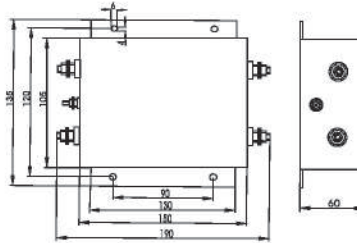

B2

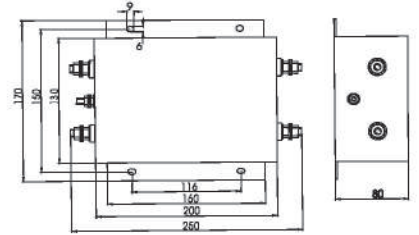

B3

Insertion Loss

———— (Common Mode)

----- (Differential Mode)

———— (Differential Mode)

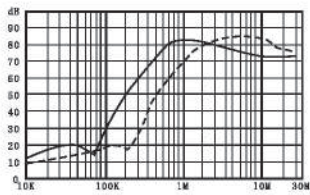

DDA1-1A

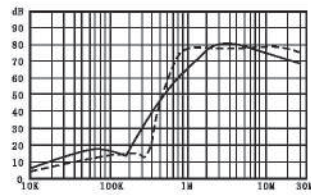

DDB1-3A

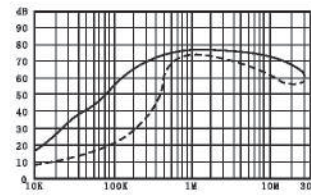

DDB1-6A

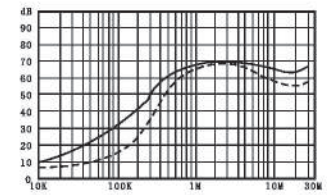

DDA4-10A

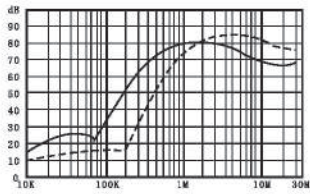

DEA1-1A

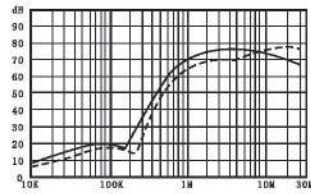

DEB1-3A

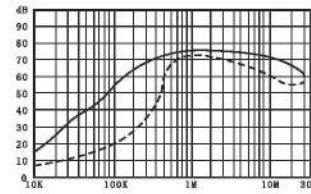

DEA4-6A

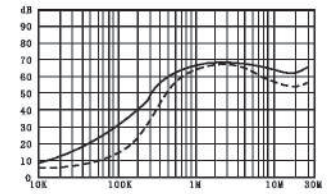

DEA4-10A

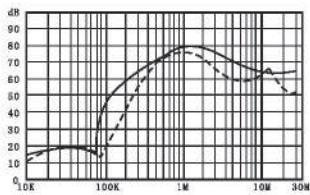

DEA5-20A

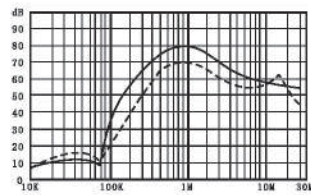

DEB2-50A

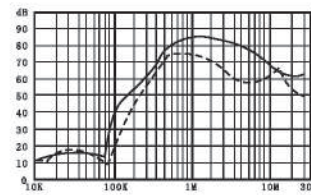

DEB3-100A

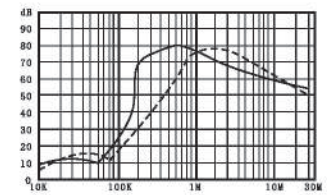

DEB1-6A

B Series Features



- Single Phase AC Filters
- The filters of two CM sections plus one DM section can provide good performance in suppressing both CM and DM noises.
- Low leakage current

Applications

- Available for Single-Chip computer systems, outstanding performance for frequency-transform interference especially.

Technical Data

Rated Voltage	115/250VAC
Line Frequency	50/60Hz
Test Voltage	1500VDC (line/line) 1500VAC (line/ground)
Insulation Resistance	> 50M Ω @500VDC
Temperature Rise	< 30 $^{\circ}$ C
Climatic category	25/085/21

List of general products

Part No.	Rated Current	Leakage Current	Dimension	Terminal		Electrical Schematics
				λ Input	H Output	
DFB1-1A	1A	<1.0mA	B1			
DFA4-3A	3A	<1.0mA	A4			
DFA5-6A	6A	<1.0mA	A5			
DFA6-6A	6A	<1.0mA	A6			
DFA7-10A	10A	<2.0mA	A7			
DFA7-20A	20A	<2.0mA	A7			
DFB3-30A	30A	<2.0mA	B3			
DFB3-50A	50A	<2.0mA	B3			

Outline Drawing and Dinemnsions(mm)

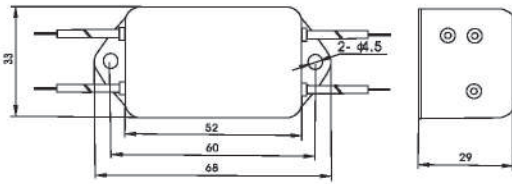

B1

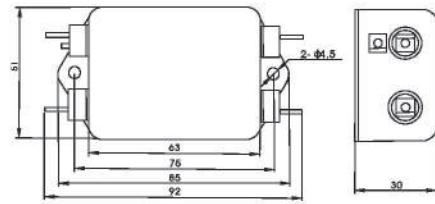

A4

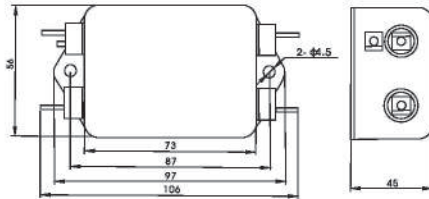

A5

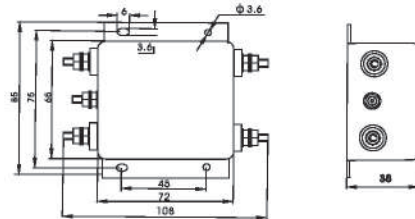

A6

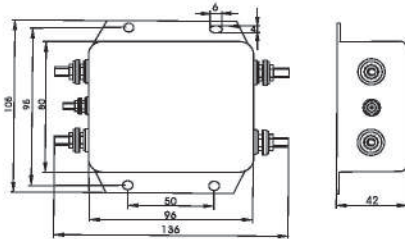

A7

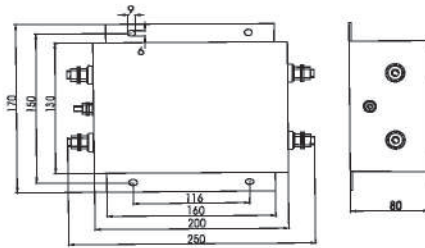

B3

Insertion Loss

———— (Common Mode)

----- (Differential Mode)

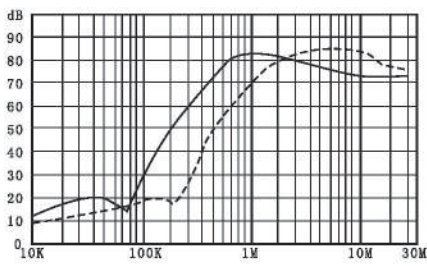

DFB1-1A

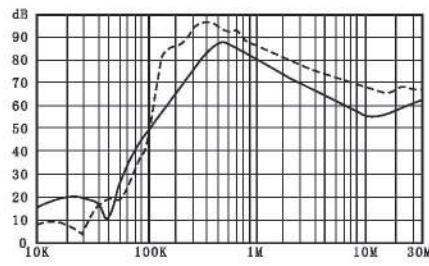

DFA4-3A

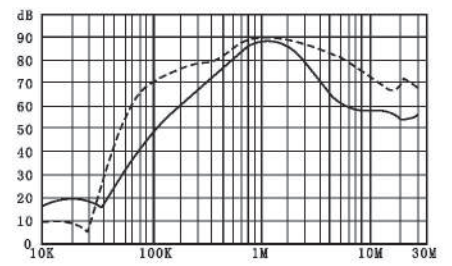

DFA5-6A

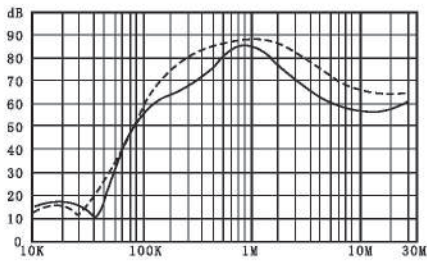

DFA6-10A

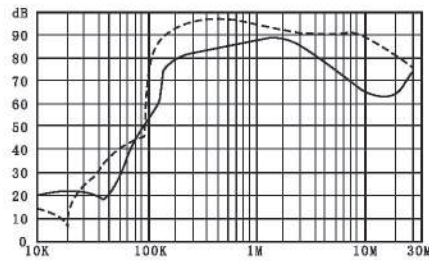

DFA6-20A

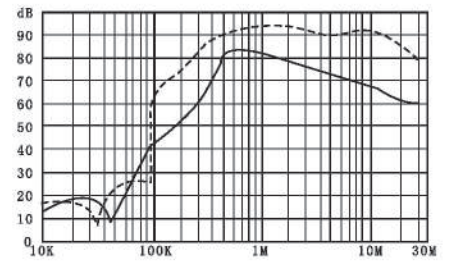

DFB3-50A

P Series

Features



- Single Phase AC Filters
- PCB mounting
- Compact unit

Applications

- Modular power supplies & mini-electronic instruments

Technical Data

Rated Voltage	115/250VAC
Line Frequency	50/60Hz
Test Voltage	1500VDC (line/line) 1500VAC (line/ground)
Insulation Resistance	> 50MΩ@500VDC
Temperature Rise	< 30°C
Climatic category	25/085/21

常规产品列表 List of general products

Part No.	Rated Current	Leakage Current	Dimension	Terminal		Electrical Schematics
				Input	Output	
DAP1-1A	1A	<0.5mA	P1	■	■	<p style="text-align: right;">A</p>
DAP1-2A	2A	<0.5mA	P1	■	■	
DAP1-3A	3A	<0.5mA	P1	■	■	
DAP1-6A	6A	<0.5mA	P1	■	■	
DBP2-1A	1A	<0.5mA	P2	■	■	<p style="text-align: right;">B</p>
DBP2-3A	3A	<0.5mA	P2	■	■	
DCP3-1A	1A	<0.5mA	P3	■	■	<p style="text-align: right;">C</p>
DCP3-3A	3A	<0.5mA	P3	■	■	

Outline Drawing and Dinemnsions(mm)

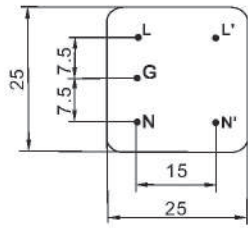

P1

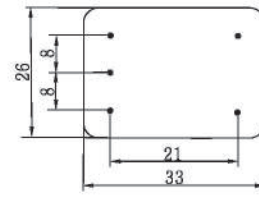
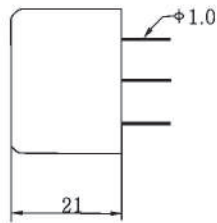

P2

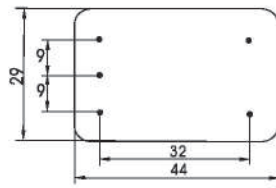
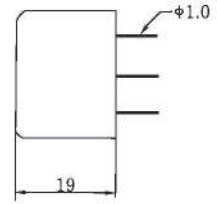

P3

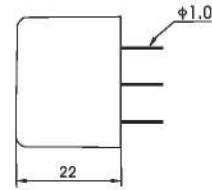

Insertion Loss

———— (Common Mode)

- - - - - (Differential Mode)

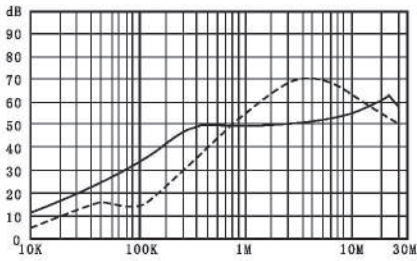

DAP1-1A

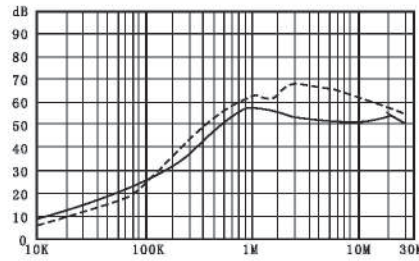

DAP1-2A

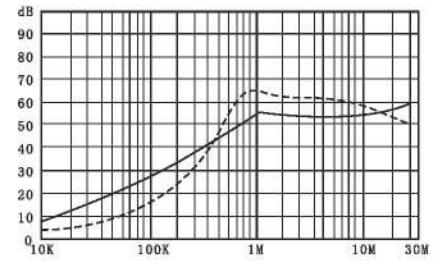

DAP1-3A

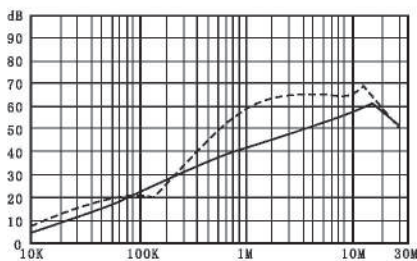

DAP1-6A

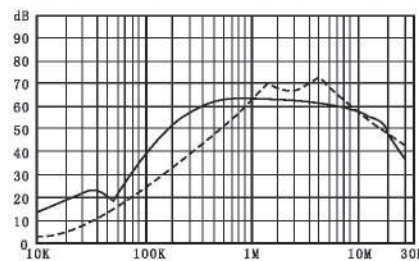

DBP2-1A

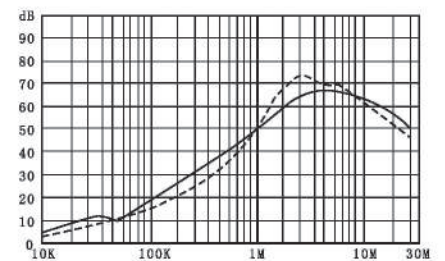

DBP2-3A

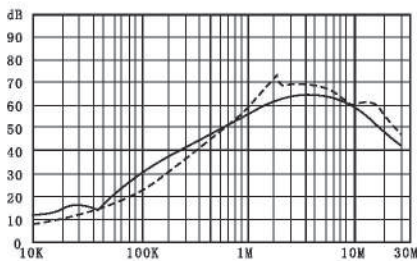

DCP3-1A

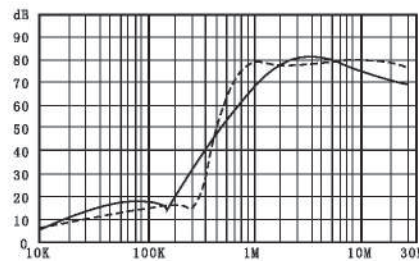

DCP3-3A

I Series

Features

- Single Phase AC Filters
- General purpose filter with IEC connector
- High ratio of performance to cost make



Applications

- Available for mini-electronic equipments and measuring instruments

Technical Data

Rated Voltage	115/250VAC
Line Frequency	50/60Hz
Test Voltage	1500VDC (line/line) 1500VAC (line/ground)
Insulation Resistance	> 50MΩ@500VDC
Temperature Rise	< 30°C
Climatic category	25/085/21

List of general products

Part No.	Rated Current	Leakage Current	Dimension	Terminal		Electrical Schematics
				Input	Output	
DAI1-1A	1A	<0.5mA	I1			
DAI1-3A	3A	<0.5mA	I1			
DAI1-6A	6A	<0.5mA	I1			
DAI1-10A	10A	<0.5mA	I1			
DAI2-1A	1A	<0.5mA	I2			
DAI2-3A	3A	<0.5mA	I2			
DAI2-6A	6A	<0.5mA	I2			
DAI2-10A	10A	<0.5mA	I2			
DAI3-15A	15A	<2.0mA	I3			
DAI4-20A	20A	<2.0mA	I4			

Outline Drawing and Dinensions(mm)

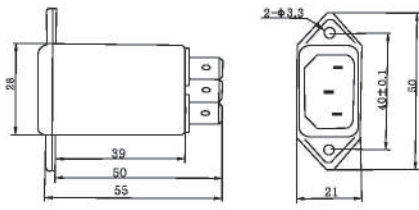

I1

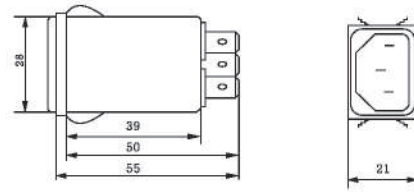

I1

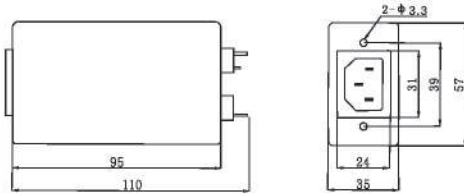

I3

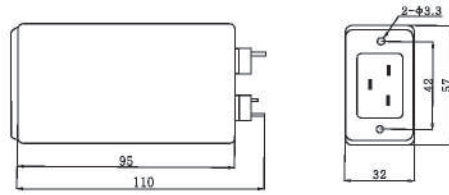

I4

Insertion Loss

———— (Common Mode)

- - - - - (Differential Mode)

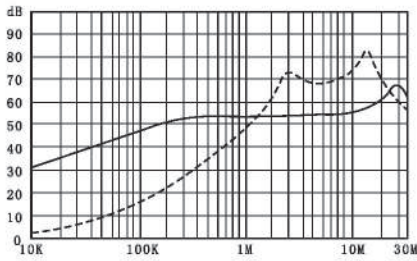

DAI1-1A

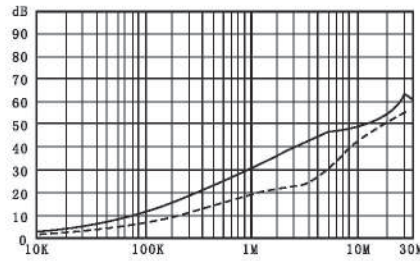

DAI1-3A

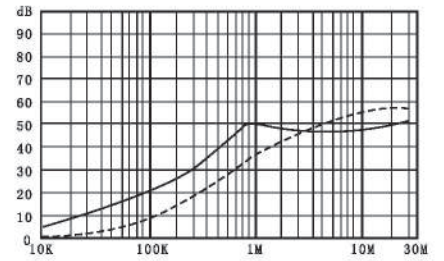

DAI1-6A

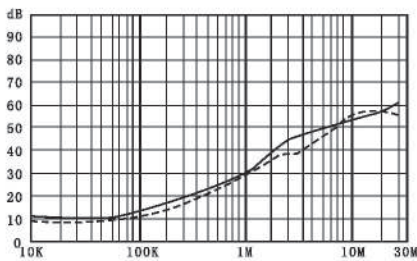

DAI1-10A

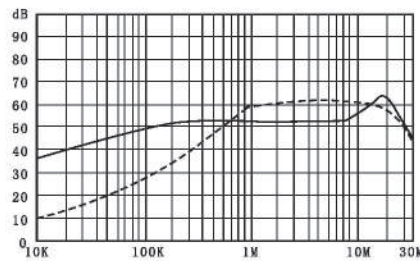

DAI2-1A

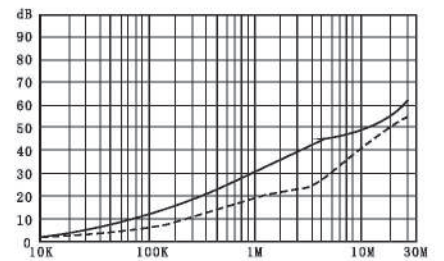

DAI2-3A

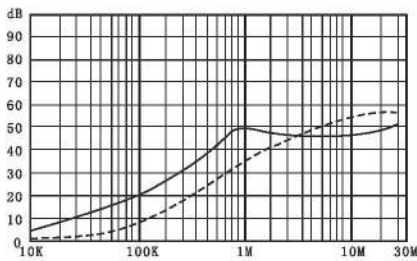

DAI2-6A

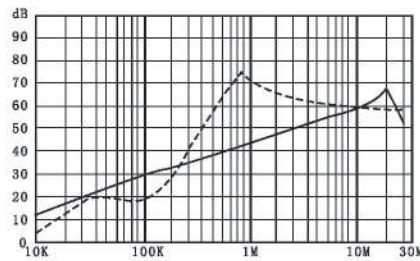

DAI3-15A

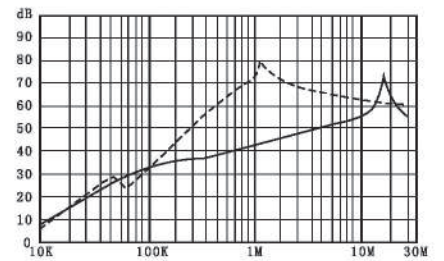

DAI4-20A



I Series

Features

- Single Phase AC Filters
- General purpose (used & switched) IEC connector for filters

Applications

- Available for mini-electronic equipments and measuring instruments

Technical Data

Rated Voltage	115/250VAC
Line Frequency	50/60Hz
Test Voltage	1500VDC (line/line) 1500VAC (line/ground)
Insulation Resistance	> 50MΩ @ 500VDC
Temperature Rise	< 30°C
Climatic category	25/085/21

List of general products

Part No.	Rated Current	Leakage Current	Dimension	Terminal		Electrical Schematics
				入 Input	出 Output	
DAI2-1A	1A	<0.5mA	I2			<p>也可做成双保险 图A</p>
DAI2-3A	3A	<0.5mA	I2			
DAI2-6A	6A	<0.5mA	I2			
DAI2-10A	10A	<0.5mA	I2			
DBI5-3A	3A	<0.5mA	I5			<p>图B</p>
DBI5-6A	6A	<0.5mA	I5			
DBI5-10A	10A	<0.5mA	I5			

Outline Drawing and Dinemnsions(mm)

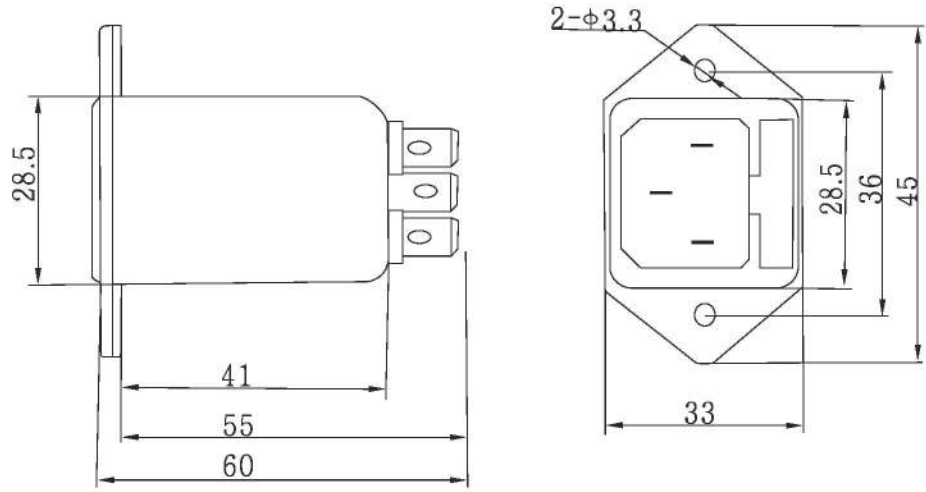

I2

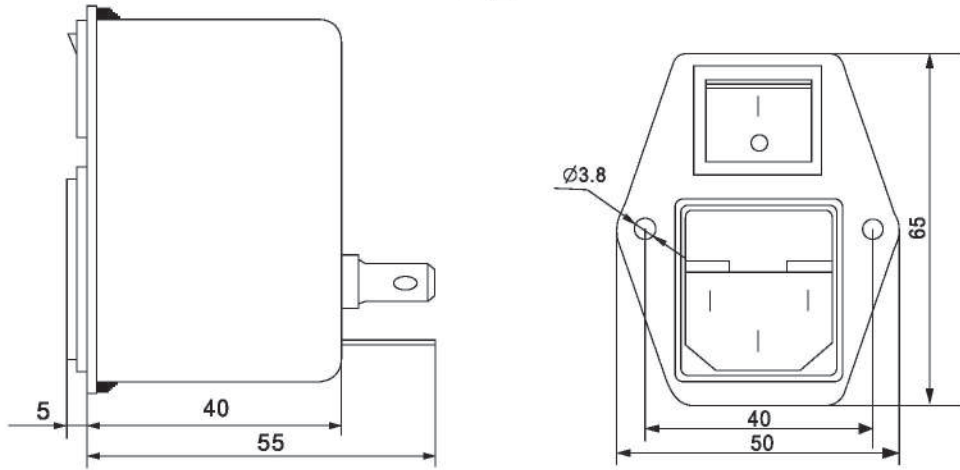

I5

Insertion Loss

(Common Mode)

(Differential Mode)

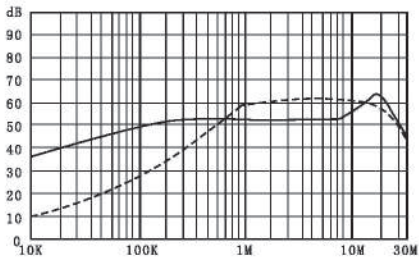

DAI2-1A

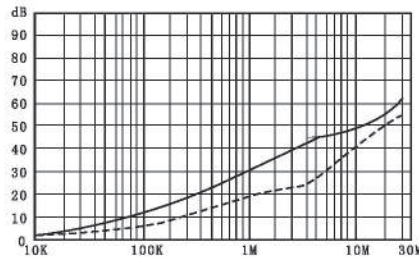

DAI2-3A

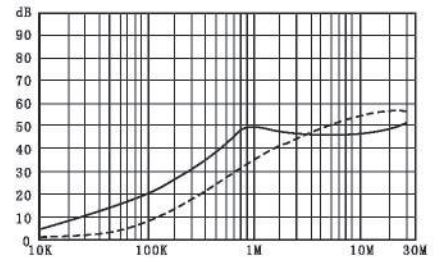

DAI2-6A



C Series Features

- 3 Phase AC Filters
- General purpose
- Feature compact, Easy to install

Applications

- Available for three phases, three lines series power supply equipments

Technical Data

Rated Voltage	250/440VAC
Line Frequency	50/60Hz
Test Voltage	1500VDC (line/line) 2250VDC (line/ground)
Insulation Resistance	> 200M Ω @500VDC
Temperature Rise	< 30 $^{\circ}$ C
Climatic category	25/085/21

List of general products

Part No.	Rated Current	Leakage Current	Dimension	Terminal		Electrical Schematics
				入 Input	出 Output	
DAC2-6A	6A	<1.5mA	C2			<p style="text-align: right;">图A</p>
DAC1-10A	10A	<1.5mA	C1			
DAC1-20A	20A	<1.5mA	C1			
DAC3-30A	30A	<1.5mA	C3			
DAC4-50A	50A	<2.0mA	C4			
DAC5-40A	40A	<2.0mA	C5			
DAC5-50A	50A	<2.0mA	C5			
DAC6-100A	100A	<2.0mA	C6			
DAC6-150A	150A	<2.0mA	C6			

Outline Drawing and Dinensions(mm)

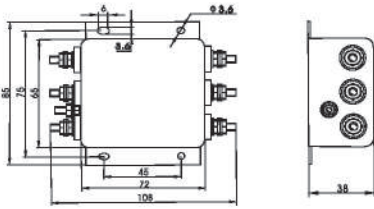

C1

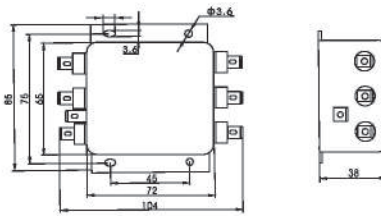

C2

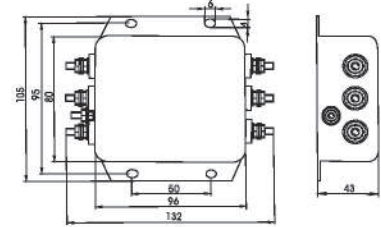

C3

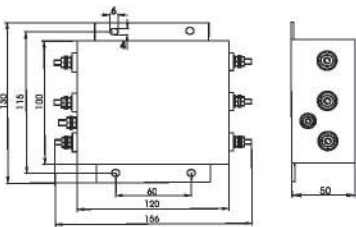

C4

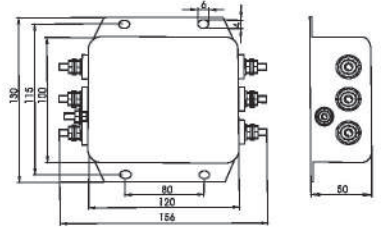

C5

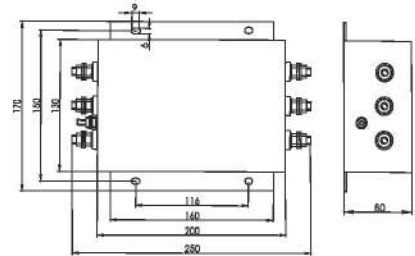

C6

Insertion Loss

———— (Common Mode)

----- (Differential Mode)

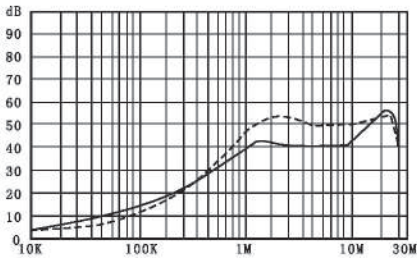

DAC2-6A

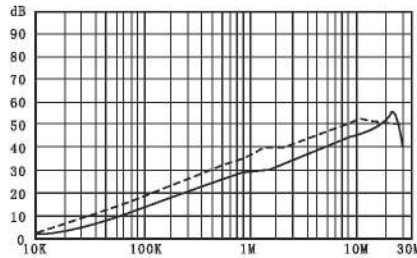

DAC1-10A

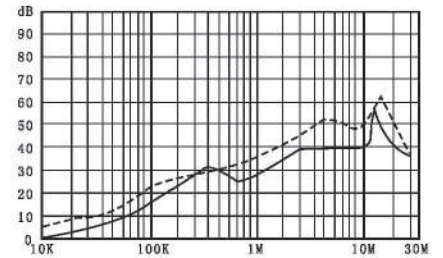

DAC3-30A

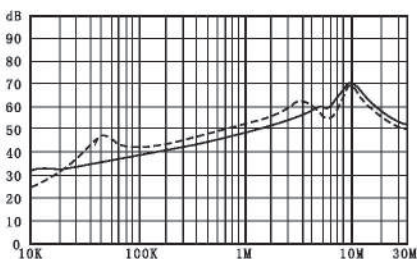

DAC5-40A

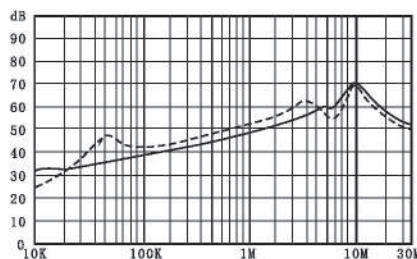

DAC5-50A

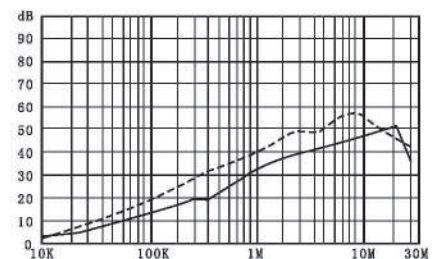

DAC4-50A

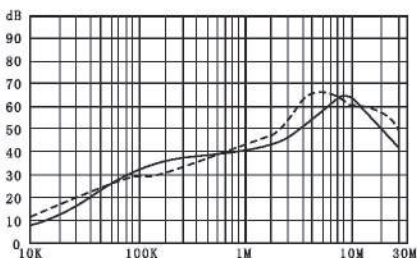

DAC6-100A

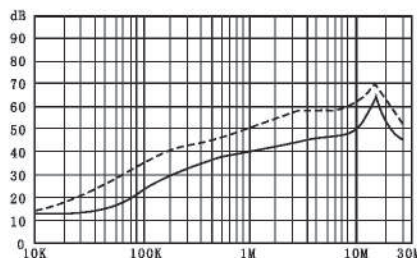

DAC6-150A



C Series

Features

- 3 Phase AC Filters
- With differential mode choke
- Can provide good performance in suppressing both CM and DM noises

Applications

- Available for three phases, three lines series power supply equipments

Technical Data

Rated Voltage	250/440VAC
Line Frequency	50/60Hz
Test Voltage	1500VDC (line/line) 2250VDC (line/ground)
Insulation Resistance	> 200M Ω @500VDC
Temperature Rise	< 30 $^{\circ}$ C
Climatic category	25/085/21

List of general products

Part No.	Rated Current	Leakage Current	Dimension	Terminal		Electrical Schematics
				入 Input	出 Output	
DBC3-6A	6A	<1.5mA	C3			<p style="text-align: center;">图B</p>
DBC3-10A	10A	<1.5mA	C3			
DBC4-20A	20A	<1.5mA	C4			
DBC4-30A	30A	<1.5mA	C4			
DBC6-50A	50A	<2.0mA	C6			
DBC7-100A	100A	<2.0mA	C7			
DBC7-150A	150A	<3.0mA	C7			
DBC8-200A	200A	<4.0mA	C8			
DCC3-6A	6A	<3.0mA	C3			<p style="text-align: center;">图C</p>
DCC3-10A	10A	<3.0mA	C3			
DCC4-20A	20A	<3.0mA	C4			
DCC6-50A	50A	<4.0mA	C6			

Outline Drawing and Dinensions(mm)

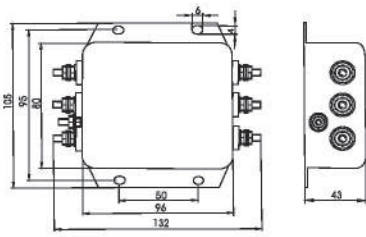

C3

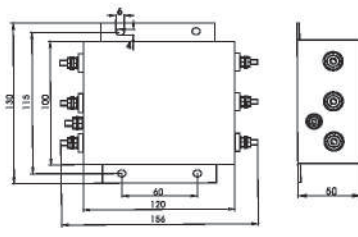

C4

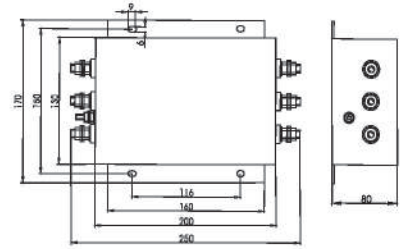

C6

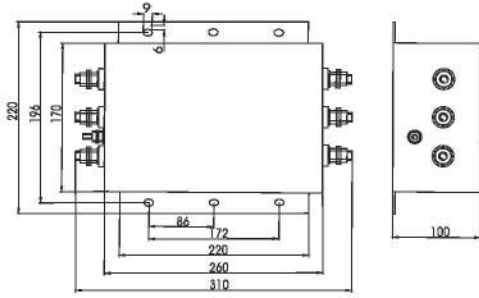

C7

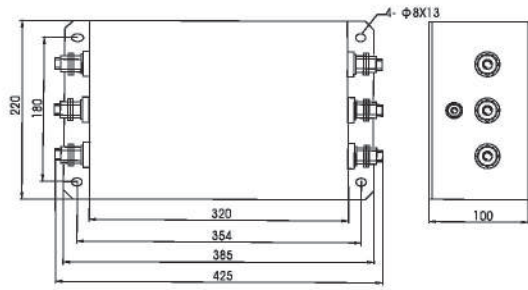

C8

Insertion Loss

———— (Common Mode)

----- (Differential Mode)

———— (Differential Mode)

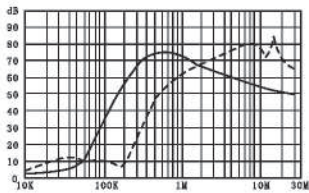

DBC3-6A

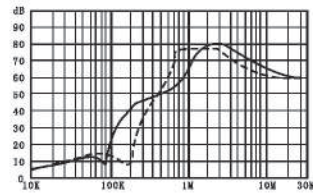

DBC3-10A

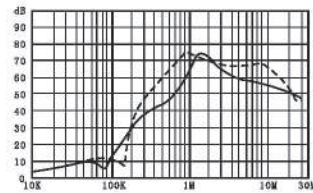

DBC4-20A

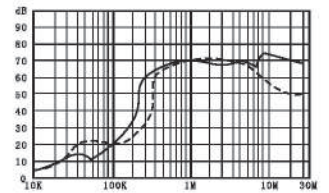

DBC4-30A

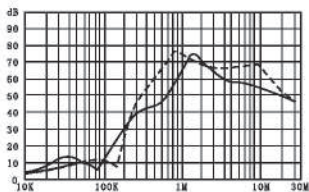

DBC6-50A

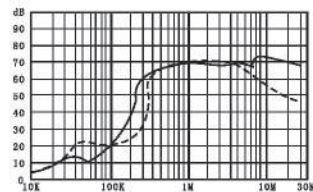

DBC7-100A

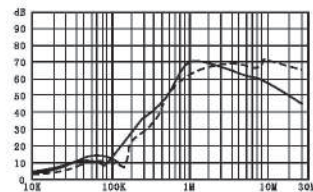

DBC7-150A

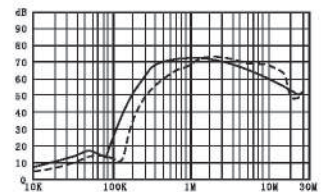

DBC8-200A

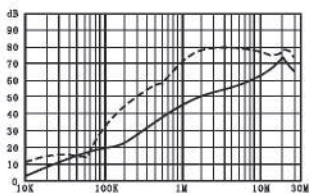

DCC3-6A

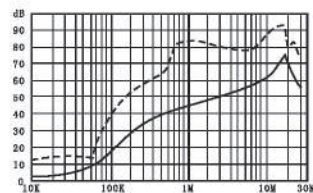

DCC3-10A

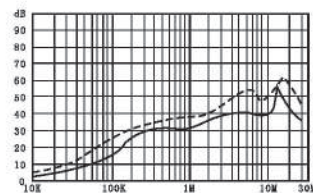

DCC4-20A

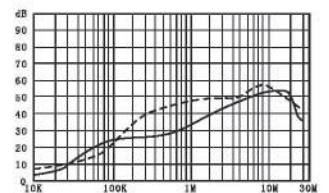

DCC6-50A

C Series

Features



- 3 Phase AC Filters
- High performance filters
- The filters of two CM sections plus one DM section
- Can provide good performance in suppressing both CM and DM noises

Applications

- Available for three phases, three lines series power supply equipments

Technical Data

Rated Voltage	250/440VAC
Line Frequency	50/60Hz
Test Voltage	1500VDC (line/line) 2250VDC (line/ground)
Insulation Resistance	> 200MΩ@500VDC
Temperature Rise	< 30°C
Climatic category	25/085/21

List of general products

Part No.	Rated Current	Leakage Current	Dimension	Terminal		Electrical Schematics
				Input	Output	
DDC4-10A	10A	<3.0mA	C4			
DDC9-20A	20A	<3.0mA	C9			
DDC6-50A	50A	<4.0mA	C6			
DDC7-100A	100A	<20mA	C7			
DDC8-150A	150A	<20mA	C8			
DDC8-200A	200A	<20mA	C8			
DDC10-300A	300A	<30mA	C10			
DDC11-600A	600A	<40mA	C11			

Outline Drawing and Dinemnsions(mm)

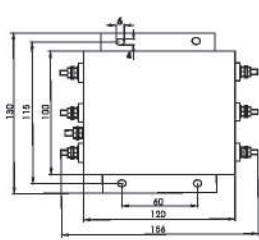

C4

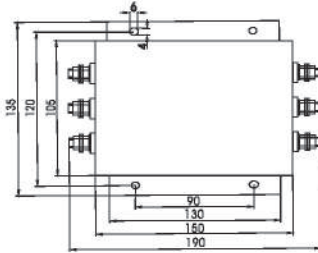

C9

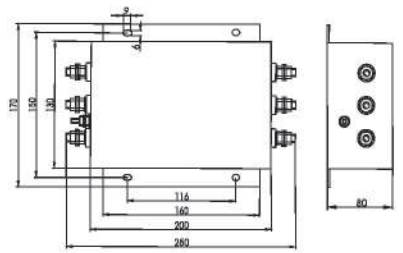

C6

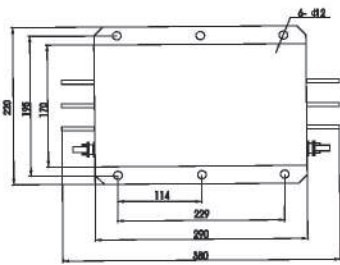

C10

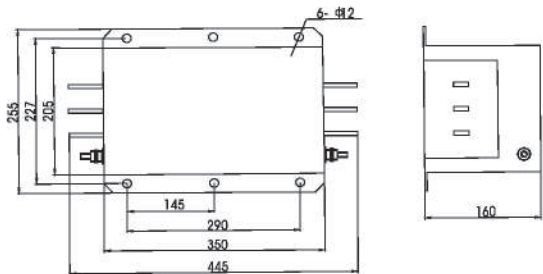

C11

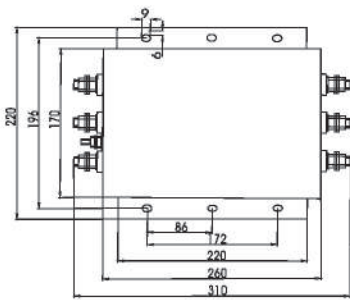

C7

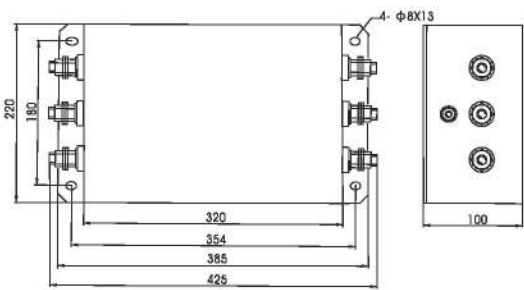

C8

Insertion Loss

———— (Common Mode) - - - - - (Differential Mode)

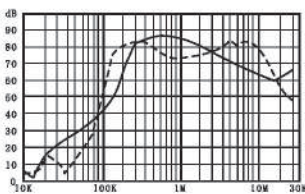

DDC4-10A

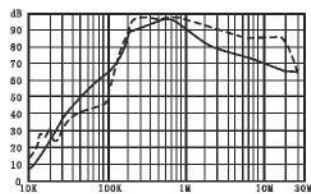

DDC9-20A

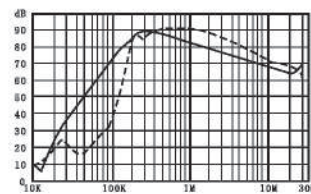

DDC6-50A

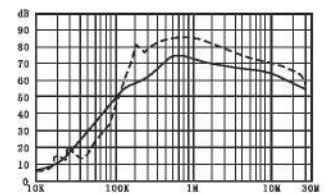

DDC7-100A

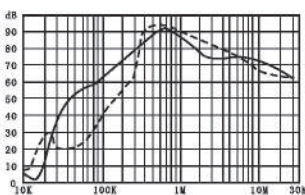

DDC8-150A

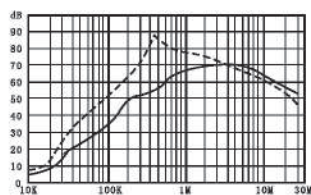

DDC8-200A

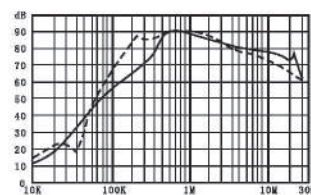

DDC10-300A

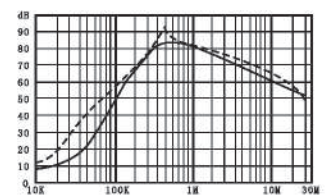

DDC11-600A

C Series

Features



- 3-phase,4-lines Filters
- Can provide good performance in suppressing both CM and DM noises
- Low leakage current

Applications

- Available for digital systems, telecom systems, medical equipments and industrial installationsts

Technical Data

Rated Voltage	250/440VAC
Line Frequency	50/60Hz
Test Voltage	1500VDC (line/line) 2250VDC (line/ground)
Insulation Resistance	> 200MΩ @ 500VDC
Temperature Rise	< 30°C
Climatic category	25/085/21

List of general products

Part No.	Rated Current	Leakage Current	Dimension	Terminal		Electrical Schematics
				入 Input	出 Output	
DAC46-6A	6A	<2.0mA	C46			<p>图A</p>
DAC46-10A	10A	<2.0mA	C46			
DAC44-100A	100A	<3.0mA	C44			
DAC44-60A	60A	<3.0mA	C44			
DBC42-10A	10A	<2.0mA	C42			<p>图B</p>
DBC42-20A	20A	<2.0mA	C42			
DBC44-50A	50A	<3.0mA	C44			
DBC44-100A	100A	<3.0mA	C44			
DCC41-6A	6A	<2.0mA	C41			<p>图C</p>
DCC41-10A	10A	<2.0mA	C41			
DCC42-20A	20A	<2.0mA	C42			

List of general products

Part No.	Rated Current	Leakage Current	Dimension	Terminal		Electrical Schematics
				Input	Output	
DCC44-50A	50A	<3.0mA	C44			<p style="text-align: center;">C</p> <p style="text-align: right;">D</p>
DDC42-10A	10A	<4.0mA	C42			
DDC43-20A	20A	<4.0mA	C43			
DDC44-50A	50A	<6.0mA	C44			
DDC45-100A	100A	<6.0mA	C45			

Outline Drawing and Dimensions(mm)

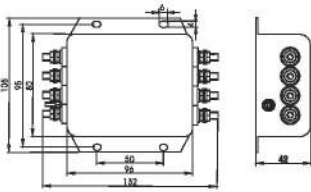

C41

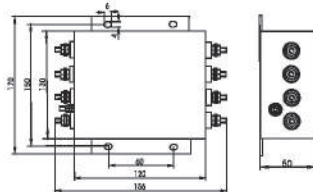

C42

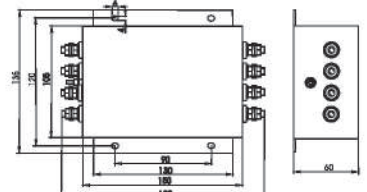

C43

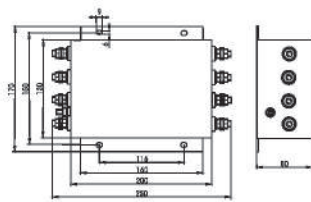

C44

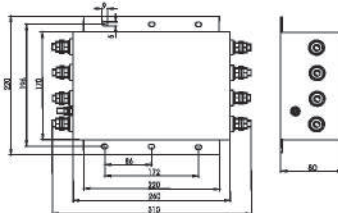

C45

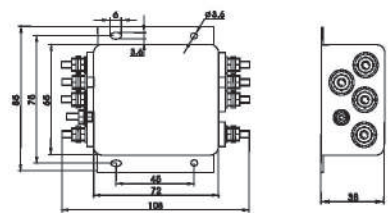

C46

Insertion Loss

(Common Mode)

(Differential Mode)

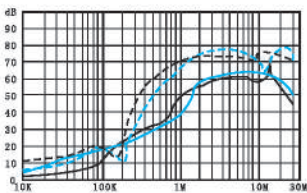

DAC46-6A, DAC46-10A

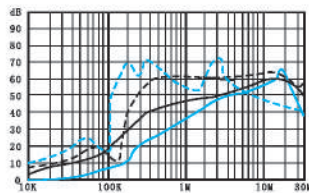

DAC44-100A, DAC44-150A

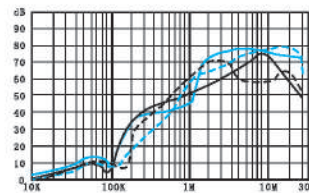

DBC42-10A, DBC42-20A

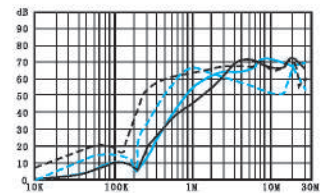

DBC44-50A, DBC44-100A

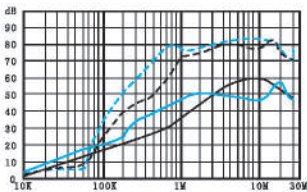

DCC41-6A, DCC41-10A

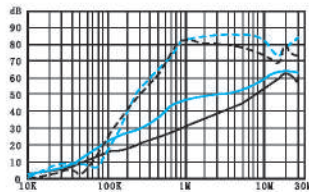

DCC42-20A, DCC44-50A

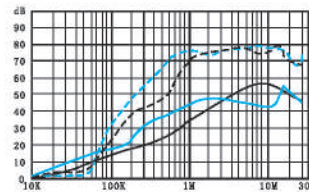

DDC42-10A, DDC43-20A

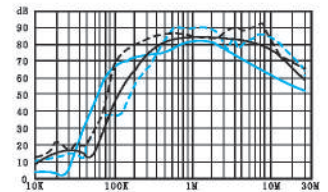

DDC44-50A, DDC45-100A

F Series

Features



- Frequency changer input end special-purpose series
- Can provide good performance in suppressing both CM and DM noises
- Low leakage current

Applications

- Suited for high performance, heavy interference environments, such as inverter speed controlled systems

Technical Data

Rated Voltage	250/440VAC
Line Frequency	50/60Hz
Test Voltage	1500VDC (line/line) 2250VAC (line/ground)
Insulation Resistance	> 200MΩ@500VDC
Temperature Rise	< 30℃
Climatic category	25/085/21

List of general products

Part No.	Rated Current	Frequency changer power (KVA)	Leakage Current	Dimension	Terminal	
					Input	Output
DF1-6A	6A	1.5~3.0	<3.0mA	F1	⚡	⚡
DF2-15/25A	15/25A	7.5/11.0	<3.0/5.0mA	F1/F2	⚡	⚡
DF2-30A	30A	15.0	<5.0mA	F2	⚡	⚡
DF2-40A	40A	18.5	<5.0mA	F2	⚡	⚡
DF2-50A	50A	22.0	<5.0mA	F2	⚡	⚡
DF3-80A	80A	37.0	<20mA	F3	⚡	⚡
DF3-100A	100A	45.0	<20mA	F3	⚡	⚡
DF3-120A	120A	50.0	<20mA	F3	⚡	⚡
DF4-150A	150A	75.0	<20mA	F4	⚡	⚡
DF5-300A	300A	110.0~132.0	<25mA	F5	铜排	铜排
DF5-400A	400A	160.0~200.0	<30mA	F5	铜排	铜排
DF6-600A	600A	300.0	<50mA	F5	铜排	铜排
DF6-800A	800A	400.0	<50mA	F5	铜排	铜排

Electrical Schematics

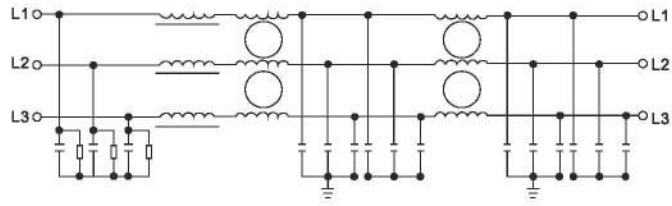

Outline Drawing and Dinensions(mm)

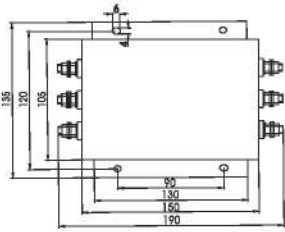

F1

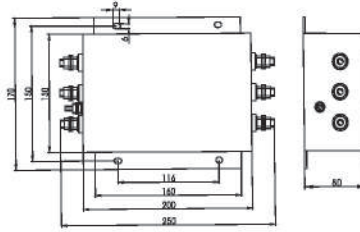

F2

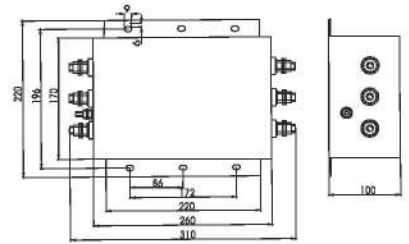

F3

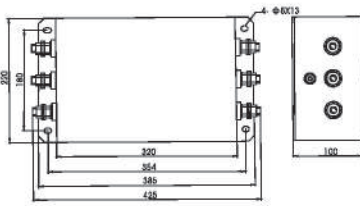

F4

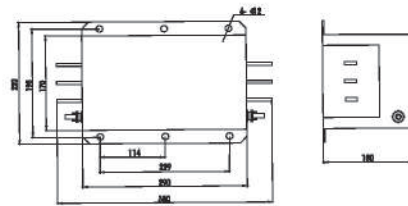

F5

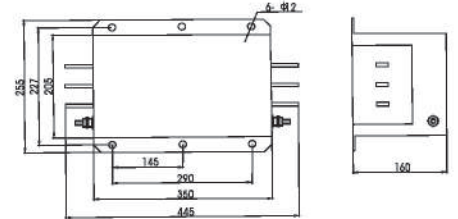

F6

Insertion Loss

(Common Mode)

(Differential Mode)

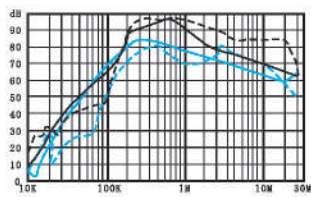

DF1-6A, DF1-15A

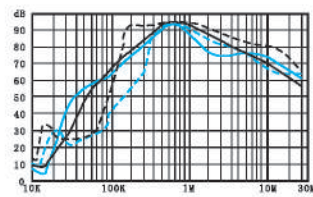

DF2-25A, DF2-30A

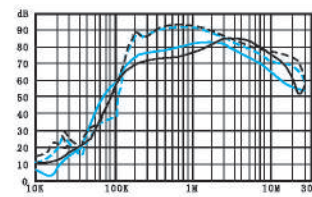

DF2-40A, DF2-50A

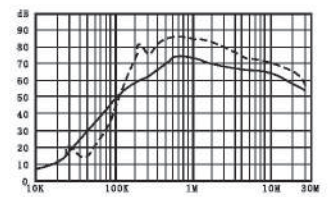

DF3-80A

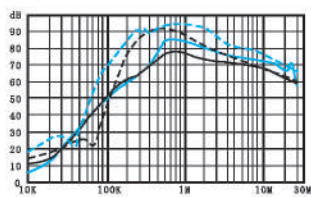

DF3-100A, DF3-120A

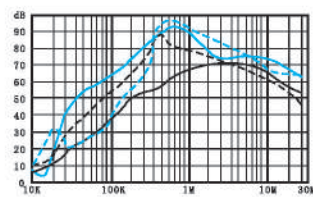

DF4-150A, DF5-300A

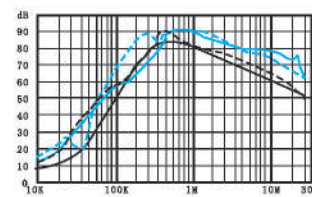

DF5-400A, DF6-650A

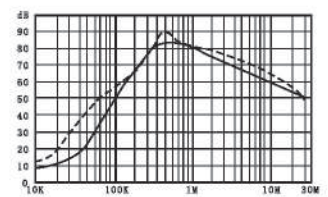

DF6-800A

F Series

Features

- Frequency changer input end special-purpose series
- Reduction of electromagnetic interference levels from inverter



Applications

- Output filter for frequency converter, UPS AC and DC inverter equipments

Technical Data

Rated Voltage	250/440VAC
Line Frequency	50/60Hz
Test Voltage	1500VDC (line/line) 2250VAC (line/ground)
Insulation Resistance	> 200MΩ@500VDC
Temperature Rise	< 30℃
Climatic category	25/085/21

List of general products

Part No.	Rated Current	(KVA) Frequency changer power	Leakage Current	Dimension	Terminal	
					Input	Output
DF7T-6/15A	6/15A	1.5~3.0/7.5		F7		
DF1T-25/30A	25/30A	11.0/15.0		F1		
DF1T-40A	40A	18.5		F1		
DF2T-50A	50A	22.0		F2		
DF2T-60A	60A	30.0		F2		
DF2T-80A	80A	37.0		F2		
DF2T-100A	100A	45.0		F2		
DF2T-120A	120A	55.0		F2		
DF3T-150A	150A	75.0		F3		
DF5T-300A	300A	110.0~132.0		F5	铜排	铜排
DF5T-400A	400A	160.0~200.0		F5	铜排	铜排
DF6T-650A	650A	300.0		F6	铜排	铜排
DF6T-800A	800A	375.0		F6	铜排	铜排

Connection Diagram

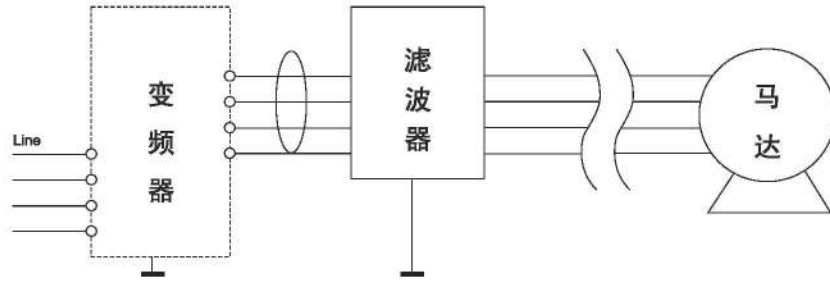

Outline Drawing and Dimensions(mm)

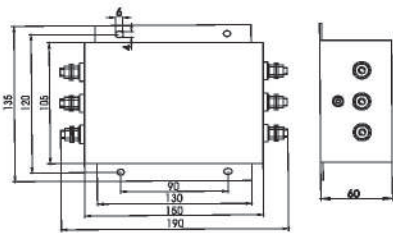

F1

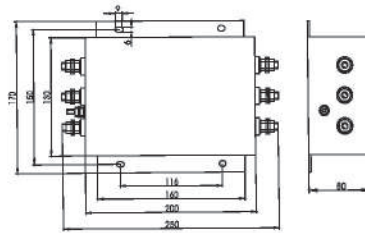

F2

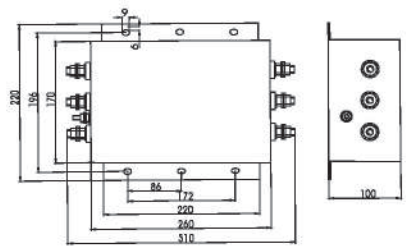

F3

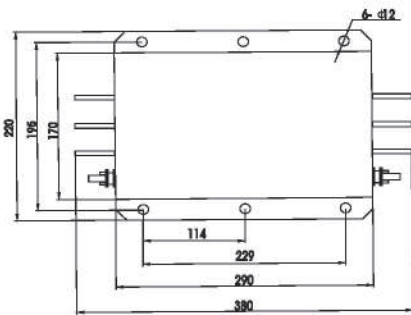

F5

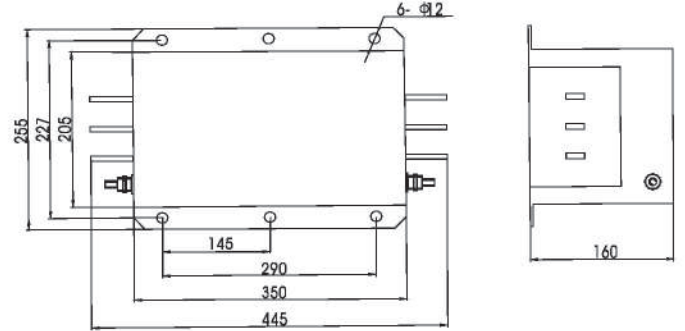

F6

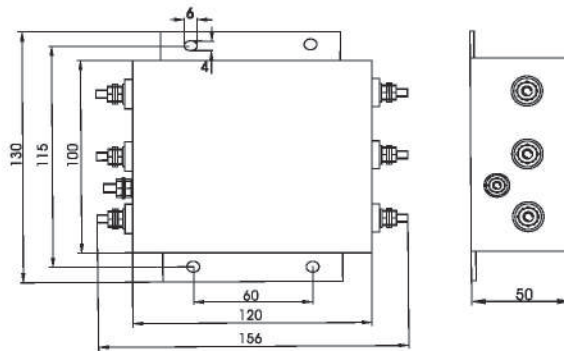

F7

D Series

Features

- DC Filters
- compact & reliable
- Specially designs for the suppression DC power line on noise

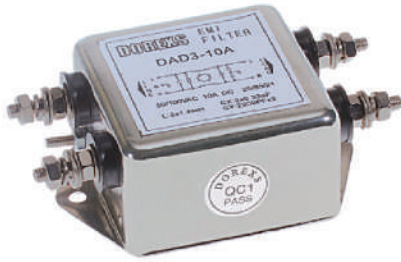

Applications

- Available for DC input of swith power supplies and various sensitive electronic instruments

Technical Data

Rated Voltage	50/100VDC
Test Voltage	350VDC (line/line) 1414VDC (line/ground)
Insulation Resistance	> 60MΩ@60VDC
Temperature Rise	< 30°C
Climatic category	25/085/21

List of general products

Part No.	Rated Current	Dimension	Terminal		Electrical Schematics	
			Input	Output		
DAD1-3A	3A	D1			<p style="text-align: right;">A</p>	
DAD2-6A	6A	D2				
DAD3-10A	10A	D3				
DAD5-20A	20A	D5				
DAD7-50A	50A	D7				
DBD1-1A	1A	D1				<p style="text-align: right;">B</p>
DBD2-3A	3A	D2				
DBD4-6A	6A	D4				
DBD5-10A	10A	D5				
DBD6-20A	20A	D6				
DBD7-50A	50A	D7				

Outline Drawing and Dinensions(mm)

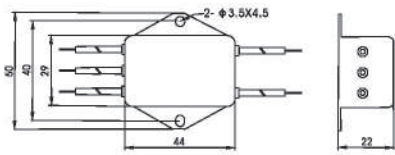

D1

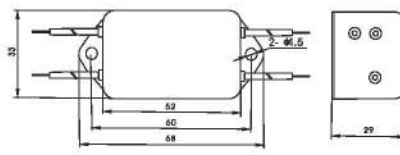

D2

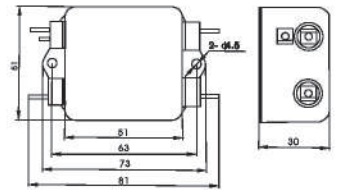

D3

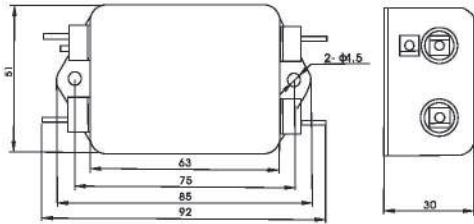

D4

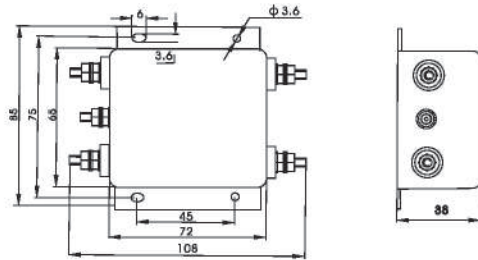

D5

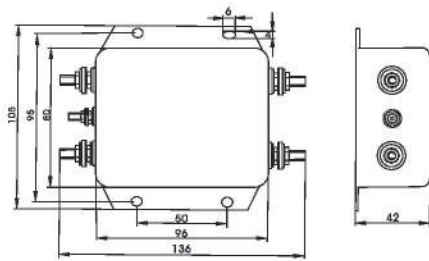

D6

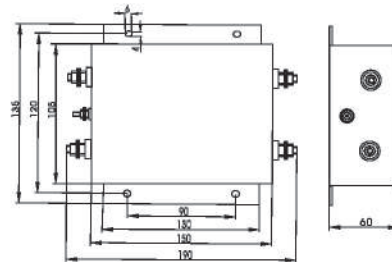

D7

Insertion Loss

———— (Common Mode)

(Differential Mode)

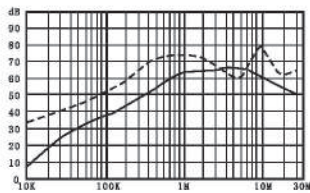

DAD1-3A

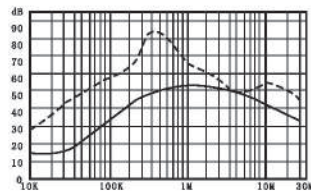

DAD2-6A

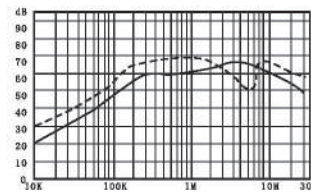

DAD3-10A

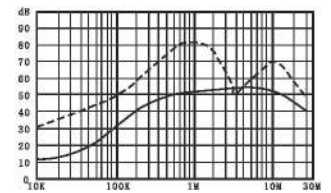

DAD5-20A

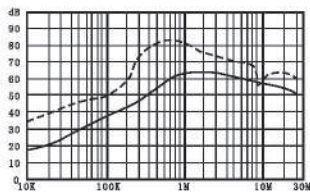

DAD7-50A

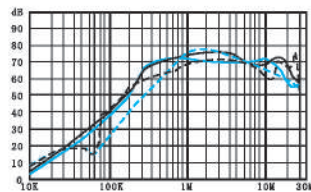

DBD1-1A, DBD2-3A

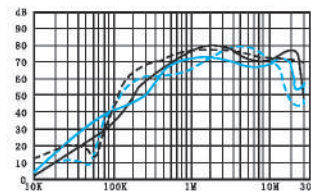

DBD4-6A, DBD5-10A

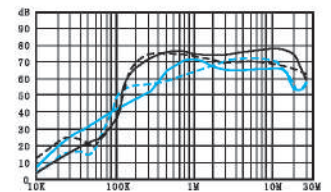

DBD6-20A, DBD7-50A

DP Series

Features

- DC Filters
- PCB mounting
- Compact, light weight, reliable



Applications

- Mode power & compact electronic instruments

Technical Data

Rated Voltage	50/100VDC
Test Voltage	350VDC (line/line) 1414VDC (line/ground)
Insulation Resistance	> 60MΩ@60VDC
Temperature Rise	< 30°C
Climatic category	25/085/21

List of general products

Part No.	Rated Current	Dimension			Electrical Schematics
			Input	Output	
DADP1-1A	1A	DP1			<p style="text-align: right;">A</p>
DADP2-0.5A	0.5A	DP2			
DADP2-2A	2A	DP2			
DBDP5-1A	1A	DP5			<p style="text-align: right;">B</p>
DBDP5-3A	3A	DP5			
DBDP4-0.5A	0.5A	DP4			
DBDP4-2A	2A	DP4			<p style="text-align: right;">C</p>
DCDP3-0.5A	0.5A	DP3			
DCDP3-2A	2A	DP3			

Outline Drawing and Dinensions(mm)

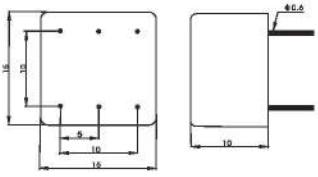

DP1

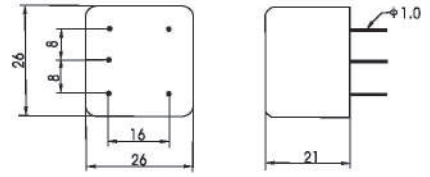

DP2

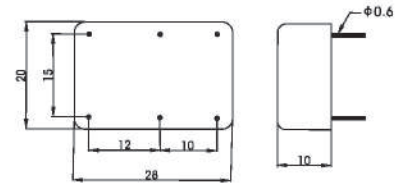

DP3

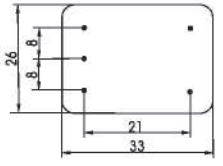

DP4

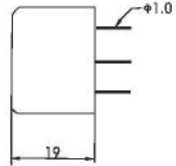

Dp5

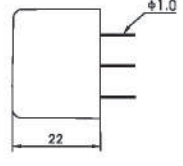

插入损耗 Insertion Loss

———— (Common Mode) - - - - - (Differential Mode)

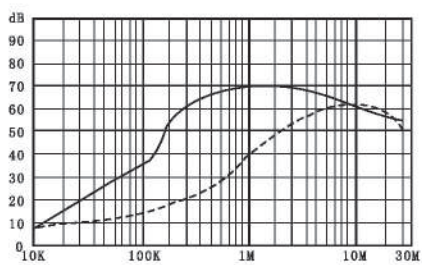

DCDP3-0.5A

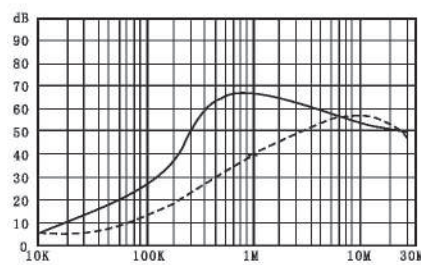

DCDP3-2A

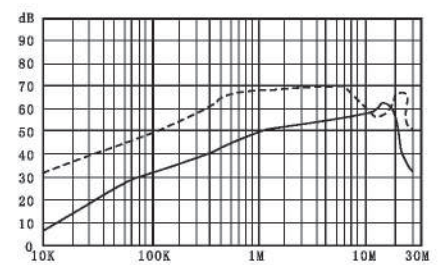

DADP1-1A

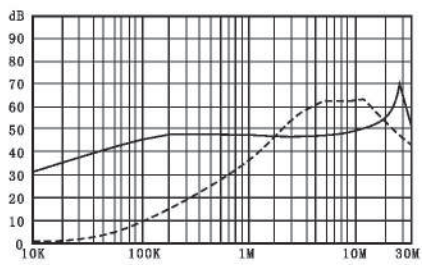

DADP2-0.5A

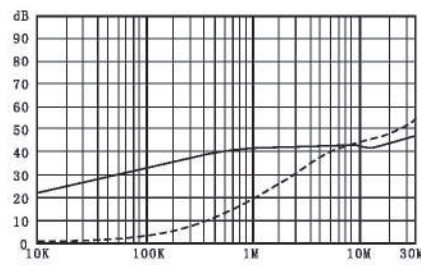

DADP2-2A

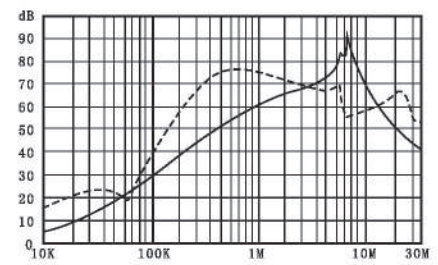

DBDP5-3A

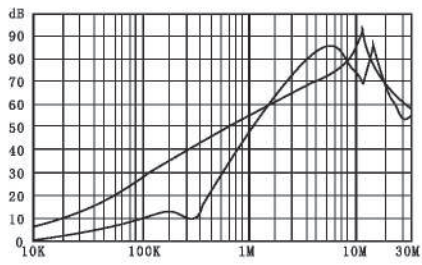

DBDP4-0.5A

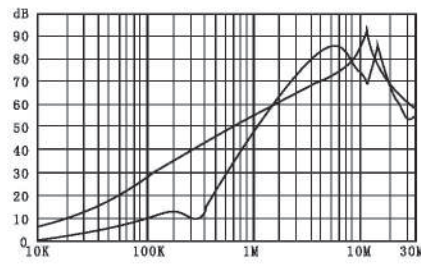

DBDP4-2A

LY Series

Features



■ Lightningproof Filters

■ Specially designs for the suppression surge disturbance, Can effectively suppress each kind of surge impact

Applications

■ Specially designs for the suppression surge disturbance, Can effectively suppress each kind of surge impact.

Technical Data

Conditions	单相	直流	三相
Rated Voltage	250VAC	80VDC	440VAC
(8/20 μ s, 10times)	5~40KA		
Insulation Resistance	> 50M Ω @500VDC		
Temperature Rise	< 30 $^{\circ}$ C		
Climatic category	25/085/21		

List of general products

Part No.	Rated Current	Leakage Current	Dimension	Terminal		Remarks
				Input	Output	
DL1-6~10A	6~10A	<1.0mA	L1			Special resistances available
DL2-10~30A	10~30A	<1.0mA	L2			
DL3-30~50A	30~50A	<1.0mA	L3			

Outline Drawing and Dinensions(mm)

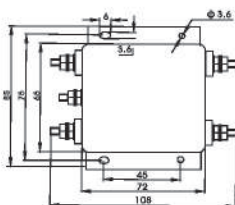

L1

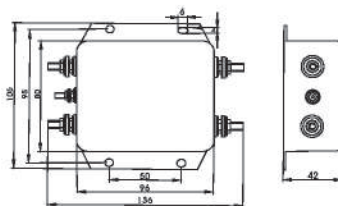

L2

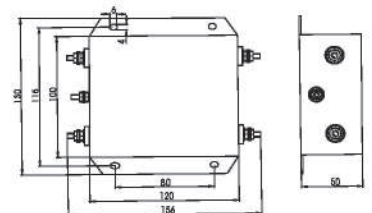

L3



MC Series Features

- EFT Suppressor Filters

- The EFT suppressor product is the principle which

The basis absorbs and reflects complements one another, used the advanced design method and unifies the many years is engaged in the electromagnetism compatible practice experience, specially aimed at the suppression fast transient group pulse disturbance designs, to suppressed the fast transient group pulse disturbance effect is extremely remarkable.

Applications

- Kind of domestic electric appliances, the electric meter, peacefully guards against the panalarm, the electrical test measuring appliance, the accelerator and so on civil or the military commercial run survey and the control device.

Technical Data

Rated Voltage	250VAC	80VDC	440VAC
Test Voltage	1500VDC	400VDC	1500VDC
	1500VAC	700VDC	2250VAC
Insulation Resistance	> 50MΩ@500VDC		
Temperature Rise	< 30℃		
Climatic category	25/085/21		

List of general products

Part No.	Rated Current	Voltage Surge Suppressor	Dimension	Terminal		Remarks
				Input	Output	
DM1-1~3A	1~3A	1KV-4KV	M1	⏏	⏏	Special resistances available
DM2-1~6A	1~6A		M2	⏏	⏏	
DM3-1~6A	1~6A		M3	⏏	⏏	
DM4-6~10A	6~10A		M4	⏏	⏏	
DM5-20A	20A		M5	⏏	⏏	
DM6-30A	30A		M6	⏏	⏏	

Outline Drawing and Dinensions(mm)

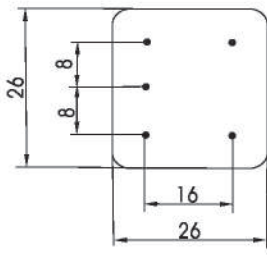

M1

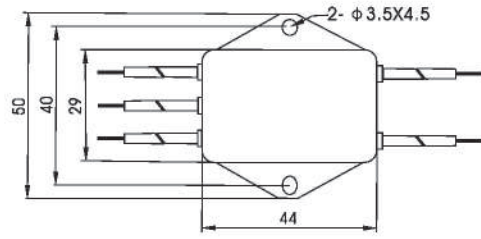
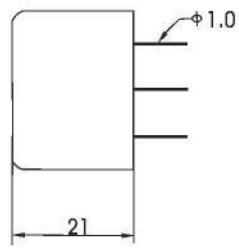

M2

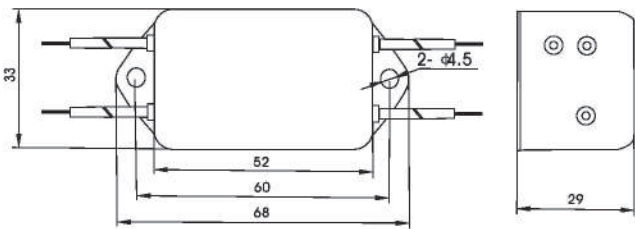
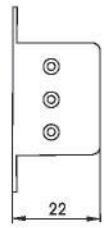

M3

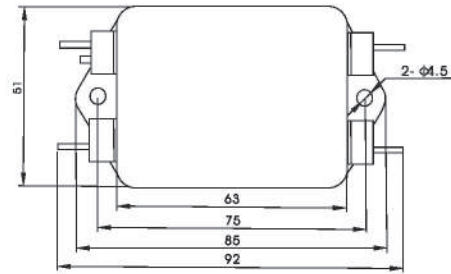
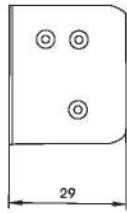

M4

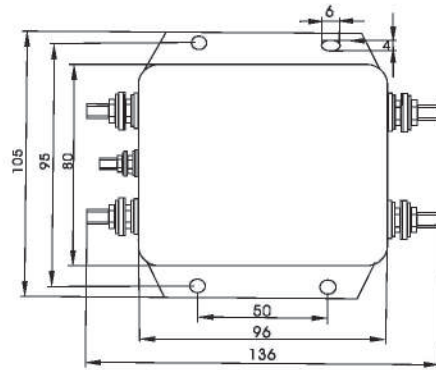
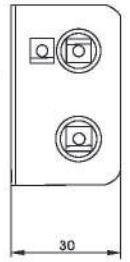

M5

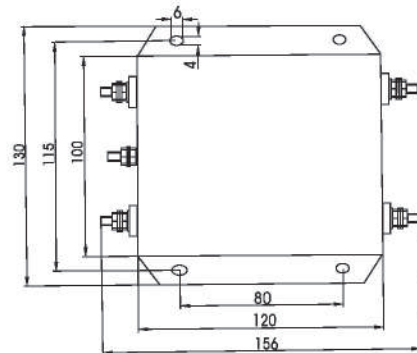
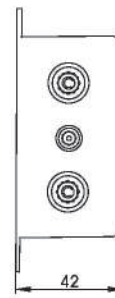

M6



Y Series

Features



- Ultralow Leakage Current Filters
- Specially designs for the medical equipment

Applications

- To satisfy the specific requirement of medical instruments or minute leakage current um-permitted

Technical Data

Rated Voltage	110/250VAC
Line Frequency	50/60Hz
Test Voltage	1500VDC (line/line) 1500VAC (line/ground)
Insulation Resistance	> 200MΩ@500VDC
Climatic category	25/085/21

List of general products

Part No.	Rated Current	Leakage Current	Dimension	Terminal		Electrical Schematic
				λ Input	⊞ Output	
DAY1-1A	1A	< 5 μ A	Y1	⊞	⊞	
DAY2-3A	3A	< 5 μ A	Y2	⊞	⊞	
DAY3-6A	6A	< 5 μ A	Y3	⊞	⊞	

Outline Drawing and Dinensions(mm)

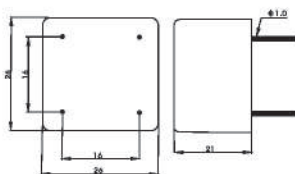

Y1

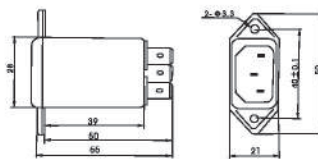

Y2

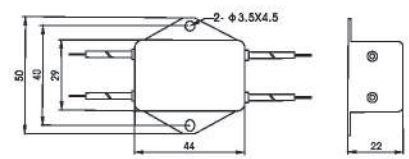

Y3



MC Series Features

- EFT Suppressor Filters

- The EFT suppresser product is the principle which

The basis absorbs and reflects complements one another,used the advanced design method and unifies the many years is engaged in the electromagnetism compatible practice experience,specially aimed at the suppression fast transient group pulse disturbance designs,to suppressed the fast transient group pulse disturbance effect is extremely remarkable.

Applications

- Kind of domestic electric appliances,the electric meter,peacefully guards against the panalarm,the electrical test measuring appliance,the accelerator and so on civil or the military commercial run survey and the control device.

Technical Data

Rated Voltage	250VAC	80VDC	440VAC
Test Voltage	1500VDC	400VDC	1500VDC
	1500VAC	700VDC	2250VAC
Insulation Resistance	> 50MΩ@500VDC		
Temperature Rise	< 30°C		
Climatic category	25/085/21		

List of general products

Part No.	Rated Current	Voltage Surge Suppressor	Dimension	Terminal		Remarks
				Input	Output	
DM1-1~3A	1~3A	1KV-4KV	M1	⏏	⏏	Special resistances available
DM2-1~6A	1~6A		M2	⏏	⏏	
DM3-1~6A	1~6A		M3	⏏	⏏	
DM4-6~10A	6~10A		M4	⏏	⏏	
DM5-20A	20A		M5	⏏	⏏	
DM6-30A	30A		M6	⏏	⏏	

J Series Features



- The CE102 conduction launch request but designs specially for the military equipment through electromagnetic compatibility military symbol GJB 151A/152A in
- Low leakage current

- Outstanding high frequency and low frequency filter characteristic

Applications

- Is suitable in each kind of military electronic installation

Technical Data

Rated Voltage	250VAC	80VDC	440VAC
Line Frequency	50Hz	DC	50Hz
(line/line)	1500VDC	400VDC	1500VDC
Test Voltage (line/ground)	1500VAC	700VDC	2250VAC
Climatic category	25/085/21		

List of general products

Part No.	Rated Current	Leakage Current	Dimension	Terminal	
				Input	Output
DJ10-1A	1A	<0.5mA	J10		
DJ10-3A	3A	<0.5mA	J10		
DJ11-1A	1A	<1.0mA	J11		
DJ11-3A	3A	<1.0mA	J11		
DJ12-3A	3A	<0.5mA	J12		
DJ13-6A	6A	<0.5mA	J13		
DJ13-10A	10A	<1.0mA	J13		
DJ14-6A	6A	<1.0mA	J14		
DJ14-10A	10A	<1.0mA	J14		

List of general products

Part No.	Rated Current	Leakage Current	Dimension	Terminal	
				Input	Output
DJ30-10A	10A	<1.0mA	J30		
DJ30-15A	15A	<1.0mA	J30		
DJ31-30A	30A	<1.0mA	J31		
DJ31-50A	50A	<1.0mA	J31		
DJ40-10A	10A	<1.0mA	J40		
DJ40-15A	15A	<1.0mA	J41		
DJ41-30A	30A	<1.0mA	J41		
DJ41-50A	50A	<1.0mA	J41		
DJ10D-1A	1A	—	J10		
DJ10D-3A	3A	—	J10		
DJ11D-3A	3A	—	J11		
DJ11D-6A	6A	—	J11		
DJ13D-6A	6A	—	J13		
DJ13D-10A	10A	—	J13		

Outline Drawing and Dinensions(mm)

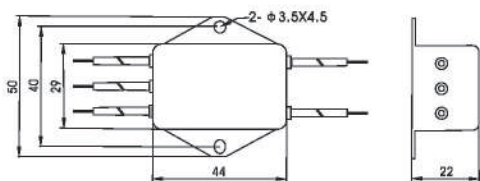

J10

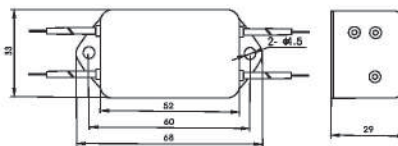

J11

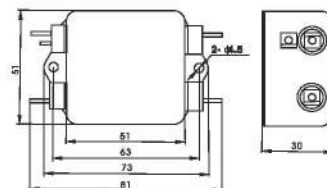

J12

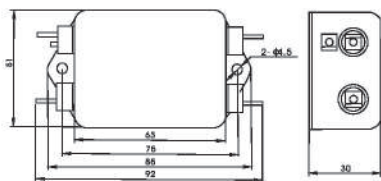

J13

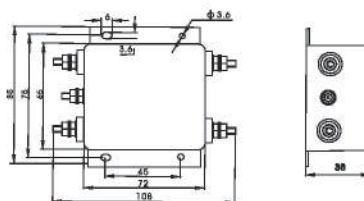

J14

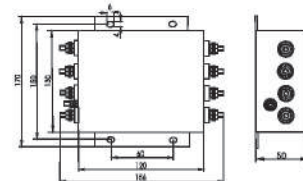

J40

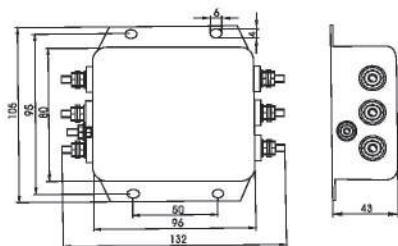

J30

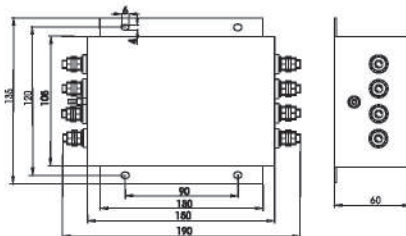

J41

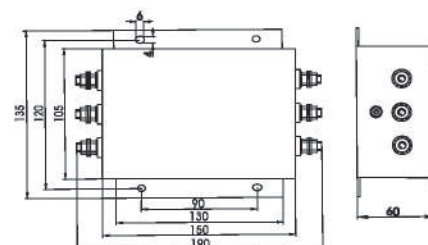

J31