



3-terminal filters

For automotive general use

YFF-AC series

YFF18AC	1608 [0603 inch]	Feed through filter
YFF21AC	2012 [0805 inch]	Feed through filter

* Dimensions Code JIS[EIA]

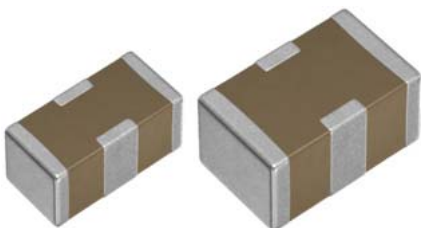

REMINDERS FOR USING THESE PRODUCTS

Before using these products, be sure to request the delivery specifications.

SAFETY REMINDERS

Please pay sufficient attention to the warnings for safe designing when using this products.

REMINDERS

1. The products listed in this specification are intended for use in automotive applications under normal operation and usage conditions. The products are not designed or warranted to meet the requirements of the applications listed below, whose performance and/or quality requires a more stringent level of safety or reliability, or whose failure, malfunction or defect could cause serious damage to society, person or property.

Please understand that we are not responsible for any damage or liability caused by use of the products in any of the applications below or for any other use exceeding the range or conditions set forth in this specification sheet. If you intend to use the products in the applications listed below or if you have special requirements exceeding the range or conditions set forth in this specification, please contact us.

- | | |
|--|--|
| (1) Aerospace/aviation equipment | (8) Public information-processing equipment |
| (2) Transportation equipment (electric trains, ships, etc.) | (9) Military equipment |
| (3) Medical equipment (excepting Pharmaceutical Affairs Law classification Class1,2) | (10) Electric heating apparatus, burning equipment |
| (4) Power-generation control equipment | (11) Disaster prevention/crime prevention equipment |
| (5) Atomic energy-related equipment | (12) Safety equipment |
| (6) Seabed equipment | (13) Other applications that are not considered general-purpose applications |
| (7) Transportation control equipment | |

When designing your equipment even for general-purpose applications, you are kindly requested to take into consideration securing protection circuit/device or providing backup circuits in your equipment.

In addition, although the products listed in this specification are intended for use in automotive applications as described above, they are not prohibited to use in general electronic equipment, whose performance and/or quality doesn't require a more stringent level of safety or reliability, or whose failure, malfunction or defect could not cause serious damage to society, person or property. Therefore, the description of this caution will be applied, when the products are used in general electronic equipment under a normal operation and usage conditions.

2. We may modify products or discontinue production of a product listed in this catalog without prior notification.
3. We provide "Delivery Specification" that explain precautions for the specifications and safety of each product listed in this catalog. We strongly recommend that you exchange these delivery specifications with customers that use one of these products.
4. If you plan to export a product listed in this catalog, keep in mind that it may be a restricted item according to the "Foreign Exchange and Foreign Trade Control Law". In such cases, it is necessary to acquire export permission in harmony with this law.
5. Any reproduction or transferring of the contents of this catalog is prohibited without prior permission from our company.
6. We are not responsible for problems that occur related to the intellectual property rights or other rights of our company or a third party when you use a product listed in this catalog. We do not grant license of these rights.
7. This catalog only applies to products purchased through our company or one of our company's official agencies. This catalog does not apply to products that are purchased through other third parties.

3-terminal filters

For automotive general use

Overview of the YFF-AC series



SERIES OVERVIEW

YFF-AC series, automotive grade of TDK's 3-terminal feed through filter, is a surface-mounted component, which has a feed-through structure that direct current passes inside the component. The structure makes a distance to GND short, and a parallel effect of the GND electrodes reduces ESL.

FEATURES

- Reduction in ESR/ESL and impedance due to the feed-through structure
- Superior attenuation characteristic in wide bandwidth
- Contributes to reduction in the number of decoupling MLCCs
- AEC-Q200 compliant

APPLICATIONS

- EMC countermeasures and decoupling use in power lines for automotive applications such as ADAS, autonomous driving system ECU

SHAPE & DIMENSIONS

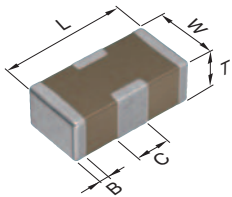

L	Body length
W	Body width
T	Body height
B	Terminal width
C	GND terminal width

PRODUCT STRUCTURES

MLCC

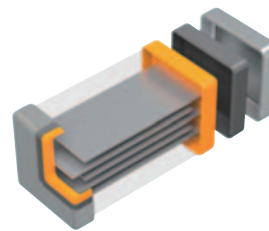

Internal electrodes are not conducting between terminal electrodes

YFF series

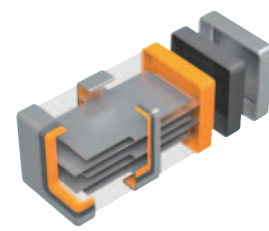

Feed-through structure that direct current passes inside the component

■ Sn
■ Ni
■ Cu

* Please refer to p-5 and 7 for details of each dimension.

○ RoHS Directive Compliant Product: See the following for more details. <https://product.tdk.com/info/en/environment/rohs/index.html>

⚠ Please be sure to request delivery specifications that provide further details on the features and specifications of the products for proper and safe use. Please note that the contents may change without any prior notice due to reasons such as upgrading.

CATALOG NUMBER CONSTRUCTION

YFF	18	AC	0G	475	M	T	0Y		E
(1)	(2)	(3)	(4)	(5)	(6)	(7)	(8)	(9)	(10)

(1) Series

(2) Dimensions L x W (mm)

Code	EIA	Length	Width	Terminal width
18	0603	1.60	0.80	0.25
21	0805	2.00	1.25	0.30

(3) Product internal code

Symbol	Description
AC	For automotive general use

(4) Rated voltage (DC)

Code	Voltage (DC)
0G	4V
0J	6.3V
1C	16V
1E	25V
1H	50V

(5) Nominal capacitance (pF)

The capacitance is expressed in three digit codes and in units of pico Farads (pF). The first and second digits identify the first and second significant figures of the capacitance. The third digit identifies the multiplier.

(Example) 101 = 100pF
 222 = 2,200pF
 105 = 1,000,000pF = 1.0μF

(6) Capacitance tolerance

Code	Tolerance
M	±20%

(7) Packaging style

Code	Style
T	Taping

(8) Internal code

Code	Description
0Y	TDK internal code

(9) Reel size (mm)

Code	Size
0	ø178
9	ø330

(10) Internal electrode

Code	Description
E, N	Ni

YFF-AC series YFF18AC type (Feed through filter)

SHAPE & DIMENSIONS

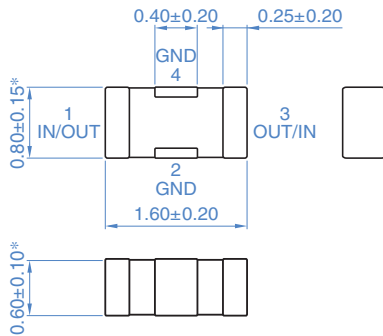

RECOMMENDED LAND PATTERN

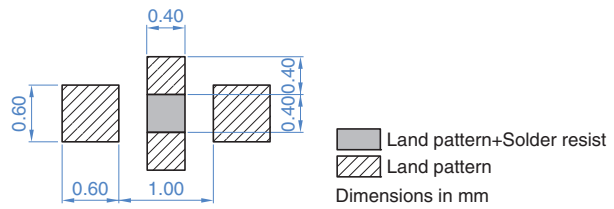

* Apply 0.80 ± 0.20 to YFF18AC0G475MT0Y0E

Make sure to connect GND terminals of a component and GND of a circuit board by using such as through-holes so that the distance between them becomes the shortest.

ELECTRICAL CHARACTERISTICS

CHARACTERISTICS SPECIFICATION TABLE

Cutoff frequency (MHz)	Insertion loss 30dB bandwidth (MHz)	Rated voltage Edc (V)	Rated current Idc (A)	Operating temperature range (°C)	Storage temperature range (After mount) (°C)	Part No.
0.01	0.05 to 3000	4	4	-55 to +125	-55 to +125	YFF18AC0G475MT0Y0E
0.1	0.23 to 3000	6.3	2	-55 to +125	-55 to +125	YFF18AC0J105MT0Y0E
0.1	0.23 to 3000	6.3	2	-55 to +125	-55 to +125	YFF18AC0J105MT0Y9E
0.1	2 to 4000	16	1	-55 to +125	-55 to +125	YFF18AC1C104MT0Y0N
0.1	2 to 4000	16	1	-55 to +125	-55 to +125	YFF18AC1C104MT0Y9N
0.3	10 to 3000	25	1	-55 to +125	-55 to +125	YFF18AC1E223MT0Y0N
0.3	10 to 3000	25	1	-55 to +125	-55 to +125	YFF18AC1E223MT0Y9N
0.6	20 to 3000	50	1	-55 to +125	-55 to +125	YFF18AC1H103MT0Y0N
0.6	20 to 3000	50	1	-55 to +125	-55 to +125	YFF18AC1H103MT0Y9N
1	40 to 3000	50	1	-55 to +125	-55 to +125	YFF18AC1H472MT0Y0N
1	40 to 3000	50	1	-55 to +125	-55 to +125	YFF18AC1H472MT0Y9N
2	90 to 3000	50	1	-55 to +125	-55 to +125	YFF18AC1H222MT0Y0N
2	90 to 3000	50	1	-55 to +125	-55 to +125	YFF18AC1H222MT0Y9N
6	200 to 3000	50	1	-55 to +125	-55 to +125	YFF18AC1H102MT0Y0N
6	200 to 3000	50	1	-55 to +125	-55 to +125	YFF18AC1H102MT0Y9N
10	400 to 6000	50	1	-55 to +125	-55 to +125	YFF18AC1H471MT0Y0N
10	400 to 6000	50	1	-55 to +125	-55 to +125	YFF18AC1H471MT0Y9N
20	800 to 6000	50	1	-55 to +125	-55 to +125	YFF18AC1H221MT0Y0N
20	800 to 6000	50	1	-55 to +125	-55 to +125	YFF18AC1H221MT0Y9N
60	1500 to 6000	50	1	-55 to +125	-55 to +125	YFF18AC1H101MT0Y0N
60	1500 to 6000	50	1	-55 to +125	-55 to +125	YFF18AC1H101MT0Y9N
100	2000 to 6000	50	1	-55 to +125	-55 to +125	YFF18AC1H470MT0Y0N
100	2000 to 6000	50	1	-55 to +125	-55 to +125	YFF18AC1H470MT0Y9N
200	4000 to 6000	50	1	-55 to +125	-55 to +125	YFF18AC1H220MT0Y0N
200	4000 to 6000	50	1	-55 to +125	-55 to +125	YFF18AC1H220MT0Y9N

⚠ Please be sure to request delivery specifications that provide further details on the features and specifications of the products for proper and safe use.
Please note that the contents may change without any prior notice due to reasons such as upgrading.

YFF-AC series YFF18AC type (Feed through filter)

■ INSERTION LOSS VS. FREQUENCY CHARACTERISTICS

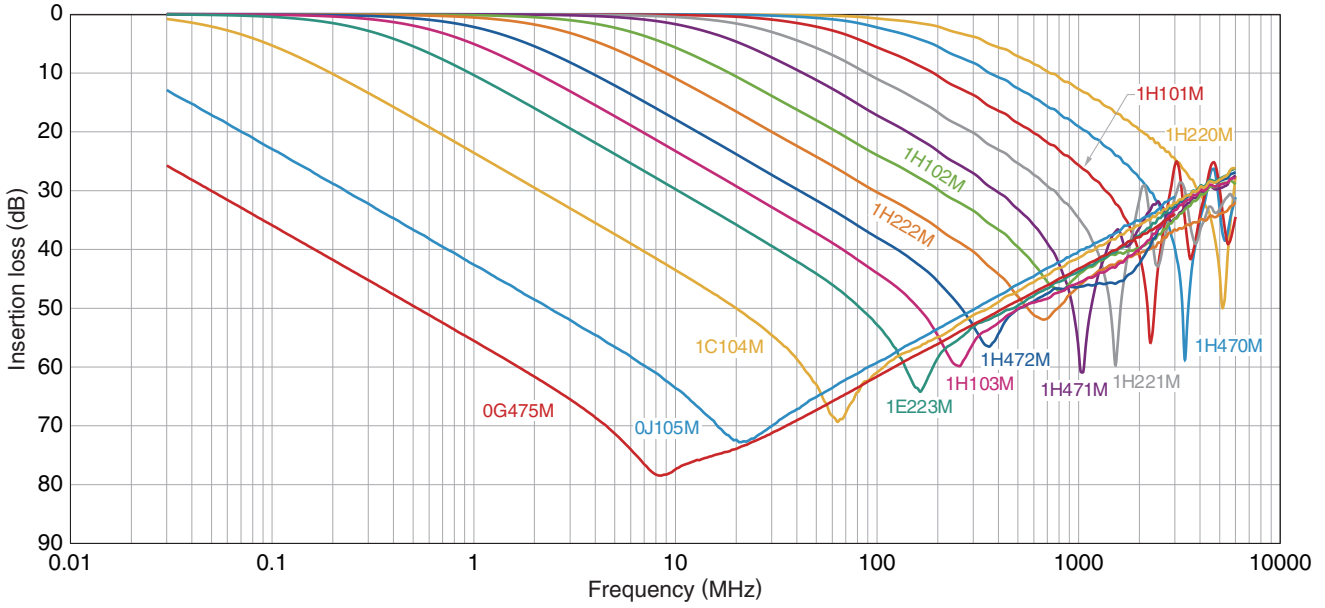

 Please be sure to request delivery specifications that provide further details on the features and specifications of the products for proper and safe use. Please note that the contents may change without any prior notice due to reasons such as upgrading.

YFF-AC series YFF21AC type (Feed through filter)

SHAPE & DIMENSIONS



RECOMMENDED LAND PATTERN

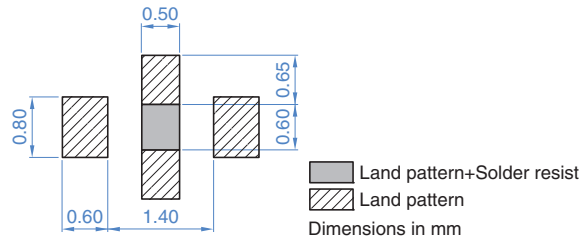

* Make sure to connect GND terminals of a component and GND of a circuit board by using such as through-holes so that the distance between them becomes the shortest.

ELECTRICAL CHARACTERISTICS

CHARACTERISTICS SPECIFICATION TABLE

Cutoff frequency (MHz)	Insertion loss 30dB bandwidth (MHz)	Rated voltage Edc (V)	Rated current Idc (A)	Operating temperature range (°C)	Storage temperature range (After mount) (°C)	Part No.
0.1	0.4 to 3000	16	1	-55 to +125	-55 to +125	YFF21AC1C474MT0Y0N
0.1	0.4 to 3000	16	1	-55 to +125	-55 to +125	YFF21AC1C474MT0Y9N
0.1	2 to 2500	25	1	-55 to +125	-55 to +125	YFF21AC1E104MT0Y0N
0.1	2 to 2500	25	1	-55 to +125	-55 to +125	YFF21AC1E104MT0Y9N
0.1	5 to 2000	25	1	-55 to +125	-55 to +125	YFF21AC1E473MT0Y0N
0.1	5 to 2000	25	1	-55 to +125	-55 to +125	YFF21AC1E473MT0Y9N
0.2	10 to 2000	25	1	-55 to +125	-55 to +125	YFF21AC1E223MT0Y0N
0.2	10 to 2000	25	1	-55 to +125	-55 to +125	YFF21AC1E223MT0Y9N
0.5	20 to 2000	25	0.4	-55 to +125	-55 to +125	YFF21AC1E103MT0Y0N
0.5	20 to 2000	25	0.4	-55 to +125	-55 to +125	YFF21AC1E103MT0Y9N
1	40 to 2000	50	0.4	-55 to +125	-55 to +125	YFF21AC1H472MT0Y0N
1	40 to 2000	50	0.4	-55 to +125	-55 to +125	YFF21AC1H472MT0Y9N
2	70 to 2000	50	0.4	-55 to +125	-55 to +125	YFF21AC1H222MT0Y0N
2	70 to 2000	50	0.4	-55 to +125	-55 to +125	YFF21AC1H222MT0Y9N
5	200 to 2000	50	0.4	-55 to +125	-55 to +125	YFF21AC1H102MT0Y0N
5	200 to 2000	50	0.4	-55 to +125	-55 to +125	YFF21AC1H102MT0Y9N
10	400 to 5000	50	1	-55 to +125	-55 to +125	YFF21AC1H471MT0Y0N
10	400 to 5000	50	1	-55 to +125	-55 to +125	YFF21AC1H471MT0Y9N
20	700 to 5000	50	1	-55 to +125	-55 to +125	YFF21AC1H221MT0Y0N
20	700 to 5000	50	1	-55 to +125	-55 to +125	YFF21AC1H221MT0Y9N
50	1000 to 5000	50	1	-55 to +125	-55 to +125	YFF21AC1H101MT0Y0N
50	1000 to 5000	50	1	-55 to +125	-55 to +125	YFF21AC1H101MT0Y9N
100	2000 to 5000	50	1	-55 to +125	-55 to +125	YFF21AC1H470MT0Y0N
100	2000 to 5000	50	1	-55 to +125	-55 to +125	YFF21AC1H470MT0Y9N
200	3000 to 5000	50	1	-55 to +125	-55 to +125	YFF21AC1H220MT0Y0N
200	3000 to 5000	50	1	-55 to +125	-55 to +125	YFF21AC1H220MT0Y9N

⚠ Please be sure to request delivery specifications that provide further details on the features and specifications of the products for proper and safe use.
Please note that the contents may change without any prior notice due to reasons such as upgrading.

YFF-AC series YFF21AC type (Feed through filter)

■ INSERTION LOSS VS. FREQUENCY CHARACTERISTICS

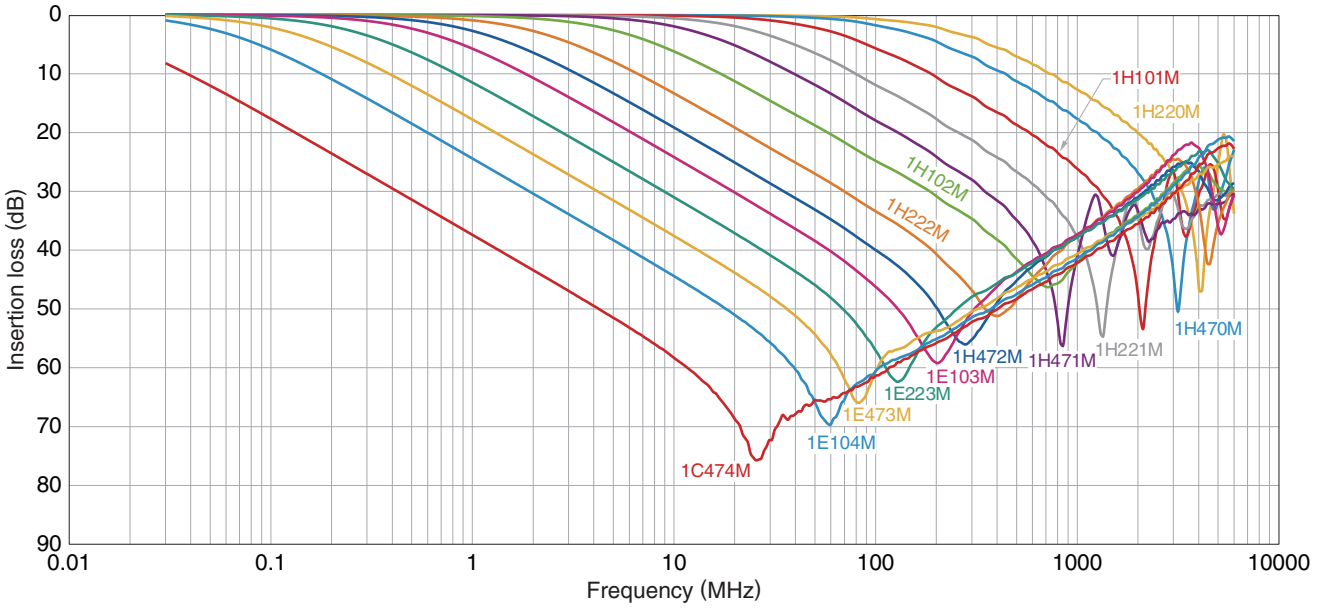

⚠ Please be sure to request delivery specifications that provide further details on the features and specifications of the products for proper and safe use. Please note that the contents may change without any prior notice due to reasons such as upgrading.