

DOSEMI

IGBT

DG40H12T2

1200V/40A IGBT with Diode

General Description

DOSEMI IGBT Power Discrete provides ultra low conduction loss as well as low switching loss. They are designed for the applications such as general inverters and UPS.

Features

- Low $V_{CE(sat)}$ Trench IGBT technology
- Low switching loss
- Maximum junction temperature 175°C
- $V_{CE(sat)}$ with positive temperature coefficient
- Fast & soft reverse recovery anti-parallel FWD

Typical Applications

- Solar Power
- Electronic welder
- Uninterruptible power supply

Equivalent Circuit Schematic

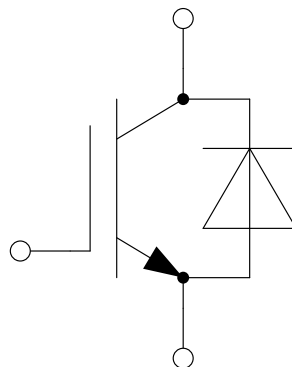

Absolute Maximum Ratings $T_C=25^\circ\text{C}$ unless otherwise noted**IGBT**

Symbol	Description	Value	Unit
V_{CES}	Collector-Emitter Voltage	1200	V
V_{GES}	Gate-Emitter Voltage Transient Gate-Emitter Voltage	± 20 -25/+30	V
I_C	Collector Current @ $T_C=25^\circ\text{C}$ @ $T_C=100^\circ\text{C}$	80 40	A
I_{CM}	Pulsed Collector Current t_p limited by T_{vjmax}	120	A
P_D	Maximum Power Dissipation @ $T_{vj}=175^\circ\text{C}$	535	W

Diode

Symbol	Description	Value	Unit
V_{RRM}	Repetitive Peak Reverse Voltage	1200	V
I_F	Diode Continuous Forward Current @ $T_C=25^\circ\text{C}$ @ $T_C=100^\circ\text{C}$	78 40	A
I_{FM}	Diode Maximum Forward Current t_p limited by T_{vjmax}	120	A

Discrete

Symbol	Description	Values	Unit
T_{viop}	Operating Junction Temperature	-40 to +175	$^\circ\text{C}$
T_{STG}	Storage Temperature Range	-55 to +150	$^\circ\text{C}$
T_S	Soldering Temperature, 1.6mm from case for 10s	260	$^\circ\text{C}$

IGBT Characteristics $T_c=25^\circ\text{C}$ unless otherwise noted

Symbol	Parameter	Test Conditions	Min.	Typ.	Max.	Unit
$V_{CE(sat)}$	Collector to Emitter Saturation Voltage	$I_C=40\text{A}, V_{GE}=15\text{V}, T_{vj}=25^\circ\text{C}$		1.90	2.35	V
		$I_C=40\text{A}, V_{GE}=15\text{V}, T_{vj}=150^\circ\text{C}$		2.40		
		$I_C=40\text{A}, V_{GE}=15\text{V}, T_{vj}=175^\circ\text{C}$		2.60		
$V_{GE(th)}$	Gate-Emitter Threshold Voltage	$I_C=1.60\text{mA}, V_{CE}=V_{GE}, T_{vj}=25^\circ\text{C}$	5.0	5.8	6.5	V
I_{CES}	Collector Cut-Off Current	$V_{CE}=V_{CES}, V_{GE}=0\text{V}, T_{vj}=25^\circ\text{C}$			200	μA
I_{GES}	Gate-Emitter Leakage Current	$V_{GE}=V_{GES}, V_{CE}=0\text{V}, T_{vj}=25^\circ\text{C}$			100	nA
R_{Gint}	Internal Gate Resistance			0		Ω
C_{ies}	Input Capacitance			7.15		nF
C_{oes}	Output Capacitance	$V_{CE}=25\text{V}, f=100\text{kHz}, V_{GE}=0\text{V}$		0.22		nF
C_{res}	Reverse Transfer Capacitance			0.11		nF
Q_G	Gate Charge	$V_{GE}=-15\dots+15\text{V}$		0.46		μC
$t_{d(on)}$	Turn-On Delay Time	$V_{CC}=600\text{V}, I_C=40\text{A}, R_G=12\Omega, V_{GE}=\pm 15\text{V}, L_S=40\text{nH}, T_{vj}=25^\circ\text{C}$		36		ns
t_r	Rise Time			92		ns
$t_{d(off)}$	Turn-Off Delay Time			92		ns
t_f	Fall Time			144		ns
E_{on}	Turn-On Switching Loss			5.66		mJ
E_{off}	Turn-Off Switching Loss		0.87		mJ	
$t_{d(on)}$	Turn-On Delay Time	$V_{CC}=600\text{V}, I_C=40\text{A}, R_G=12\Omega, V_{GE}=\pm 15\text{V}, L_S=40\text{nH}, T_{vj}=150^\circ\text{C}$		38		ns
t_r	Rise Time			92		ns
$t_{d(off)}$	Turn-Off Delay Time			104		ns
t_f	Fall Time			251		ns
E_{on}	Turn-On Switching Loss			6.72		mJ
E_{off}	Turn-Off Switching Loss		1.29		mJ	
$t_{d(on)}$	Turn-On Delay Time	$V_{CC}=600\text{V}, I_C=40\text{A}, R_G=12\Omega, V_{GE}=\pm 15\text{V}, L_S=40\text{nH}, T_{vj}=175^\circ\text{C}$		39		ns
t_r	Rise Time			102		ns
$t_{d(off)}$	Turn-Off Delay Time			113		ns
t_f	Fall Time			256		ns
E_{on}	Turn-On Switching Loss			6.81		mJ
E_{off}	Turn-Off Switching Loss		1.38		mJ	

Diode Characteristics $T_C=25^\circ\text{C}$ unless otherwise noted

Symbol	Parameter	Test Conditions	Min.	Typ.	Max.	Unit
V_F	Diode Forward Voltage	$I_F=40\text{A}, V_{GE}=0\text{V}, T_{vj}=25^\circ\text{C}$		1.95	2.40	V
		$I_F=40\text{A}, V_{GE}=0\text{V}, T_{vj}=150^\circ\text{C}$		2.00		
		$I_F=40\text{A}, V_{GE}=0\text{V}, T_{vj}=175^\circ\text{C}$		2.00		
t_{rr}	Diode Reverse Recovery Time	$V_R=600\text{V}, I_F=40\text{A},$ $-di/dt=320\text{A}/\mu\text{s}, V_{GE}=-15\text{V},$ $L_S=40\text{nH},$ $T_{vj}=25^\circ\text{C}$		286		ns
Q_r	Recovered Charge			3.73		μC
I_{RM}	Peak Reverse Recovery Current			17		A
E_{rec}	Reverse Recovery Energy			1.49		mJ
t_{rr}	Diode Reverse Recovery Time	$V_R=600\text{V}, I_F=40\text{A},$ $-di/dt=350\text{A}/\mu\text{s}, V_{GE}=-15\text{V},$ $L_S=40\text{nH},$ $T_{vj}=150^\circ\text{C}$		393		ns
Q_r	Recovered Charge			8.96		μC
I_{RM}	Peak Reverse Recovery Current			29		A
E_{rec}	Reverse Recovery Energy			3.69		mJ
t_{rr}	Diode Reverse Recovery Time	$V_R=600\text{V}, I_F=40\text{A},$ $-di/dt=400\text{A}/\mu\text{s}, V_{GE}=-15\text{V},$ $L_S=40\text{nH},$ $T_{vj}=175^\circ\text{C}$		396		ns
Q_r	Recovered Charge			9.98		μC
I_{RM}	Peak Reverse Recovery Current			33		A
E_{rec}	Reverse Recovery Energy			4.16		mJ

Discrete Characteristics $T_C=25^\circ\text{C}$ unless otherwise noted

Symbol	Parameter	Min.	Typ.	Max.	Unit
R_{thJC}	Junction-to-Case (per IGBT)			0.280	K/W
	Junction-to-Case (per Diode)			0.559	
R_{thJA}	Junction-to-Ambient		40		K/W

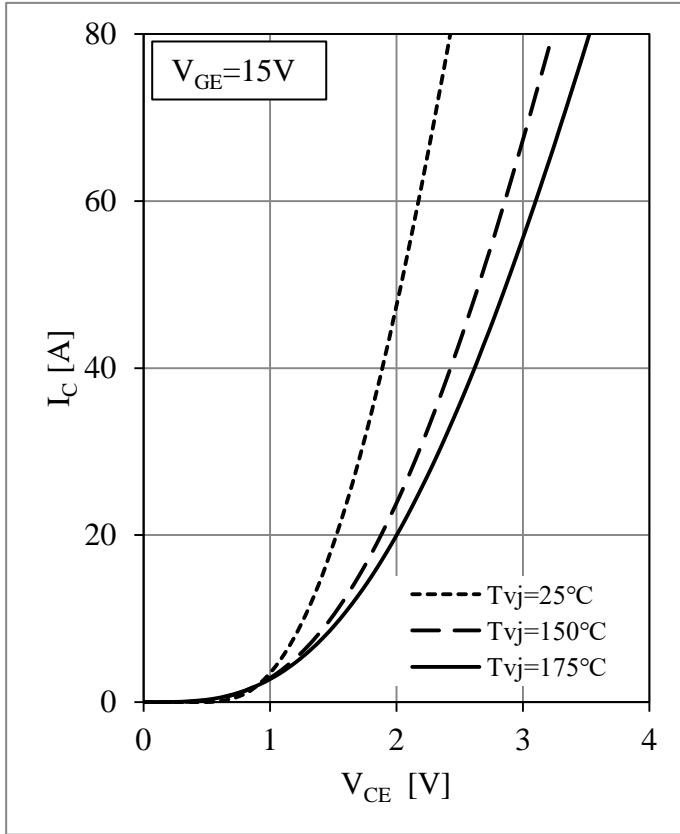

Fig 1. IGBT-inverter Output Characteristics

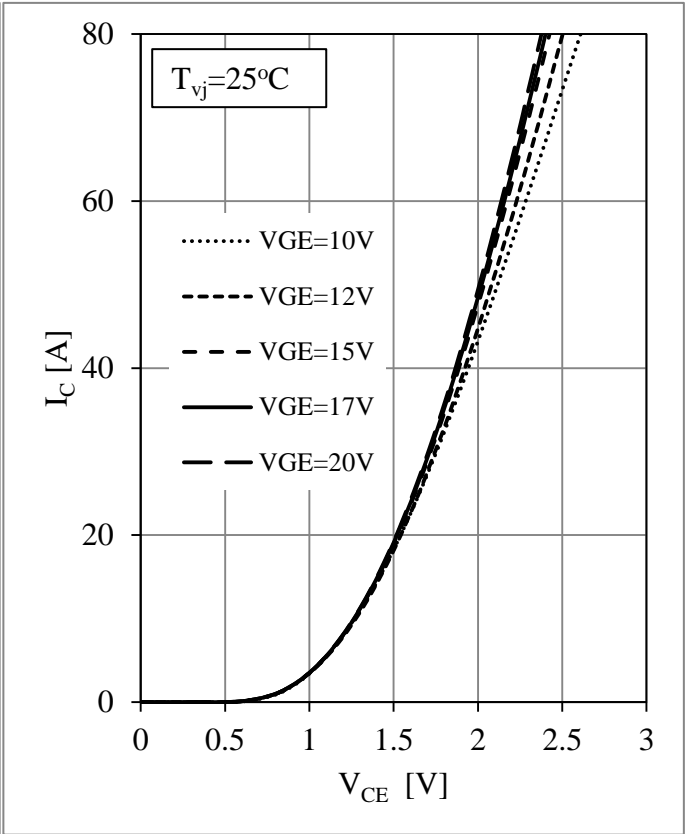

Fig 2. IGBT Output Characteristics

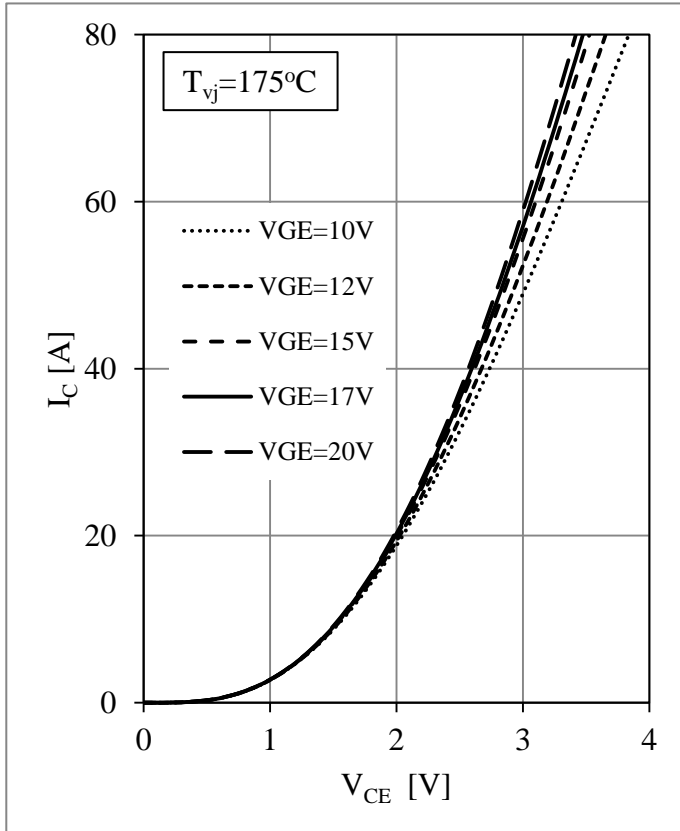

Fig 3. IGBT Output Characteristics

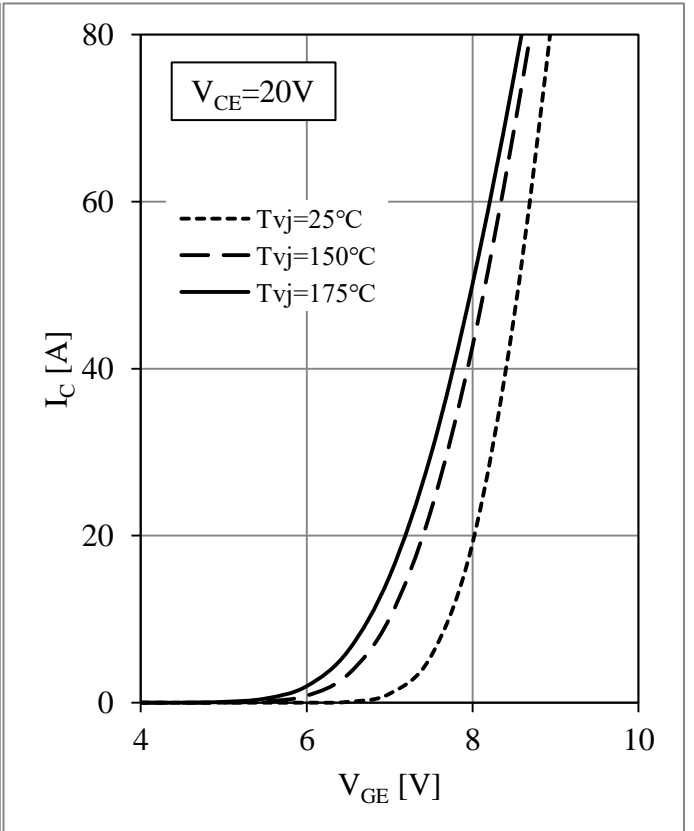

Fig 4. IGBT Transfer Characteristics

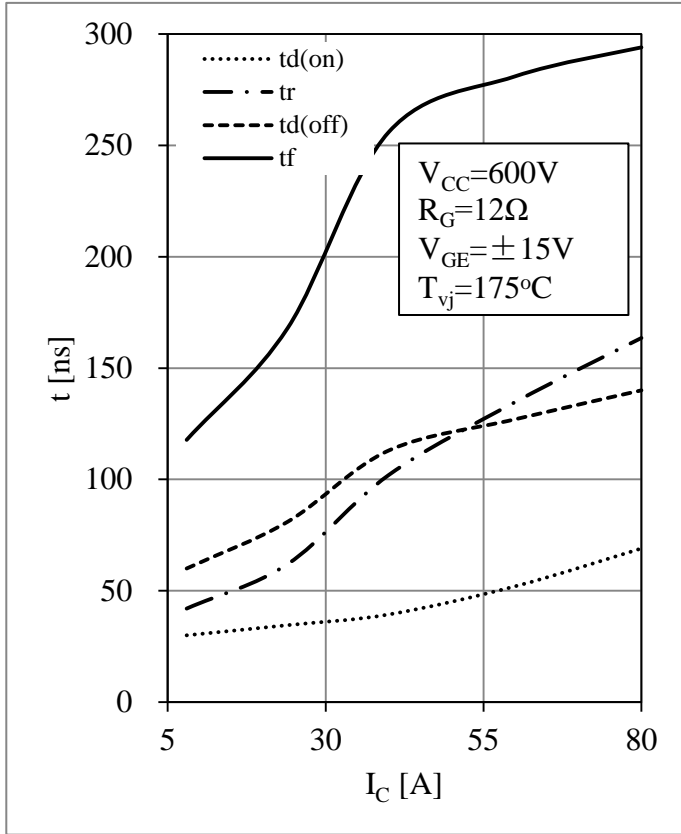

Fig 5. IGBT Switching Times as. I_C

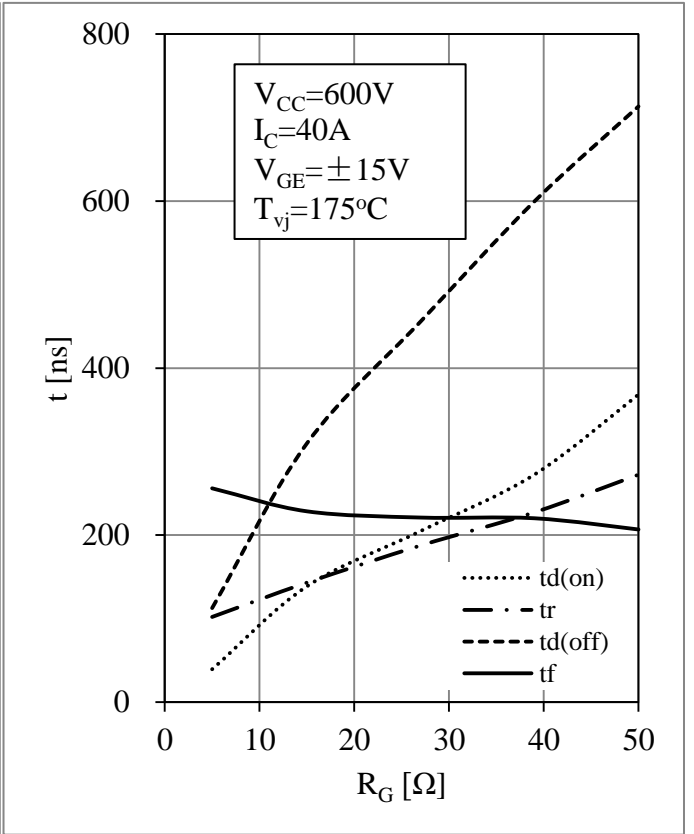

Fig 6. IGBT Switching Times as. R_G

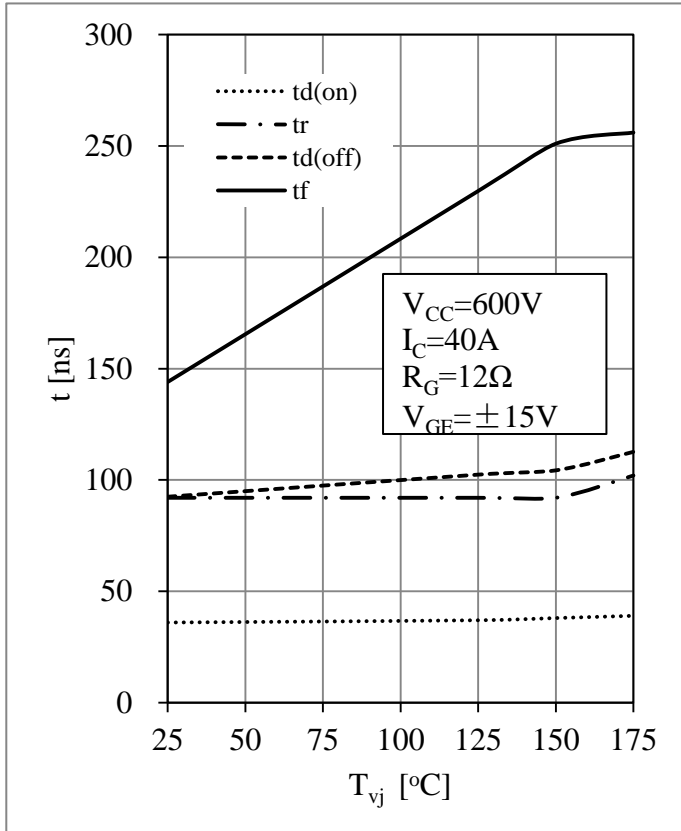

Fig 7. IGBT Switching Times vs. T_{vj}

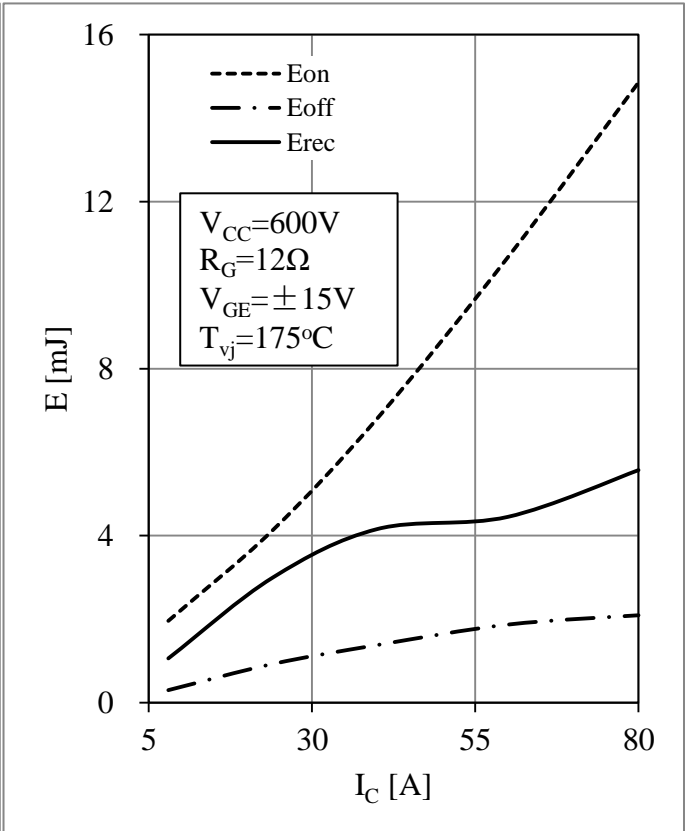

Fig 8. Switching Energy Loss vs. I_C

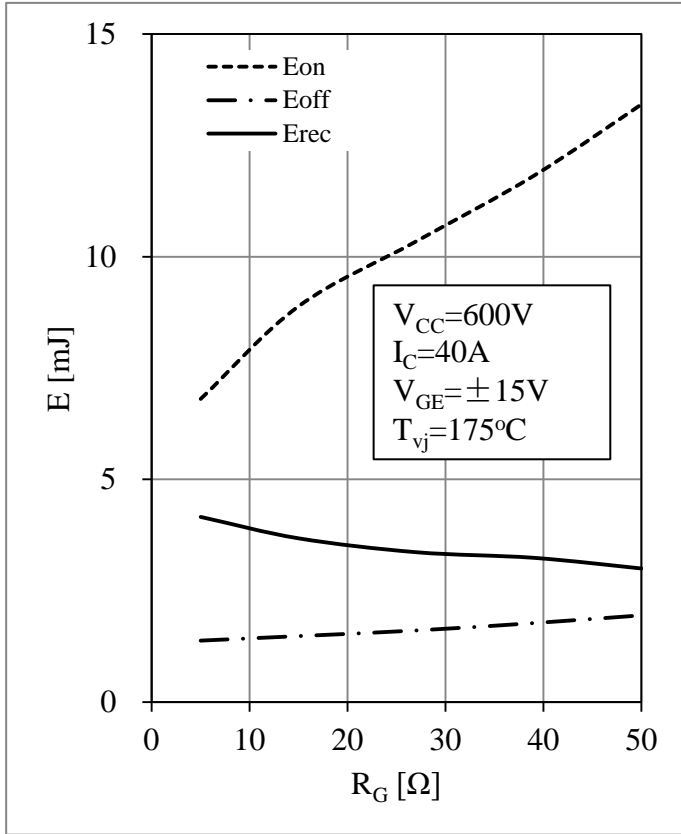

Fig 9. Switching Energy Loss vs. R_G

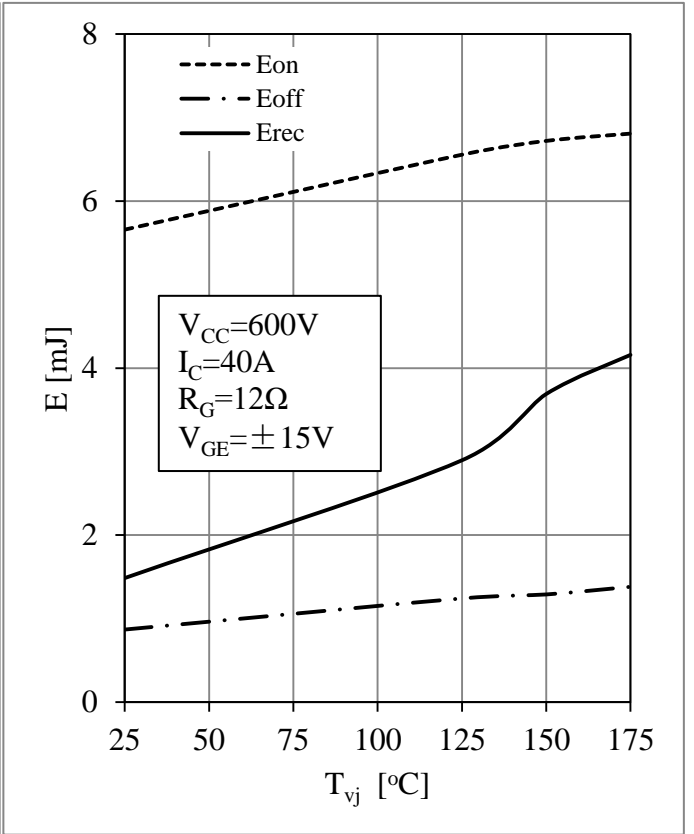

Fig 10. Switching Energy Loss vs. T_{vj}

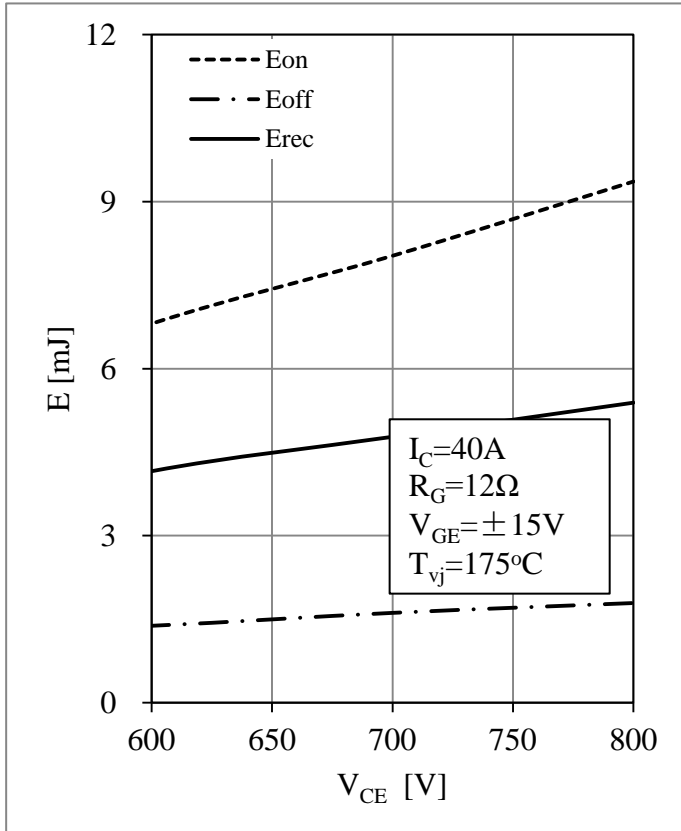

Fig 11. Switching Energy Loss vs. V_{CE}

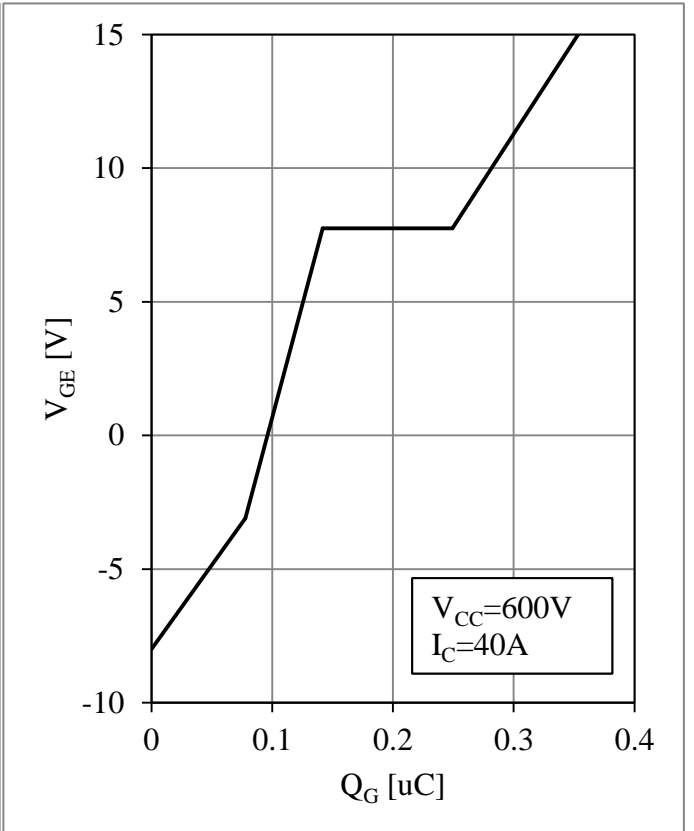

Fig 12. IGBT Gate Charge vs. V_{GE}

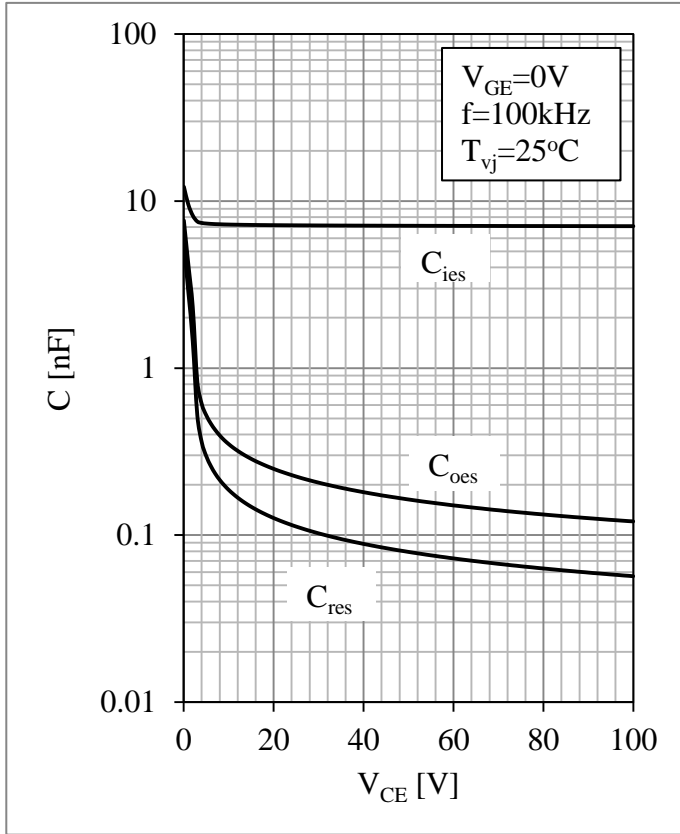

Fig 13. IGBT Capacity Characteristic

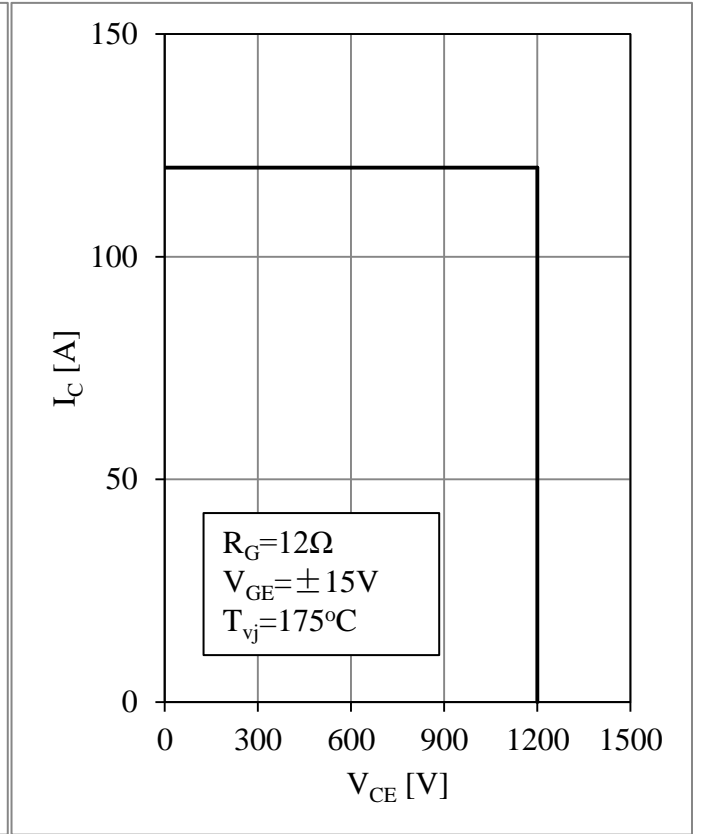

Fig 14. RBSOA

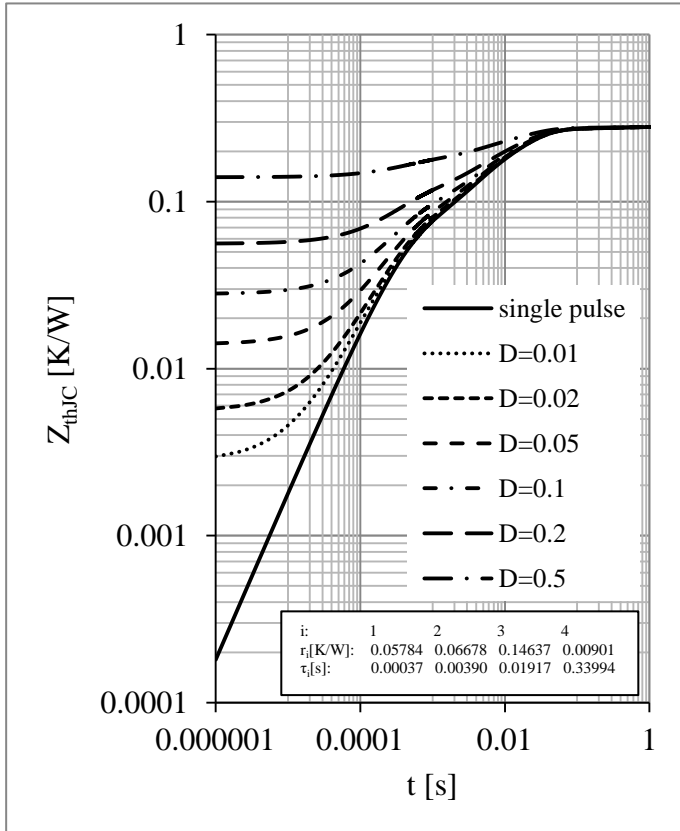

Fig 15. IGBT Transient Thermal Impedance

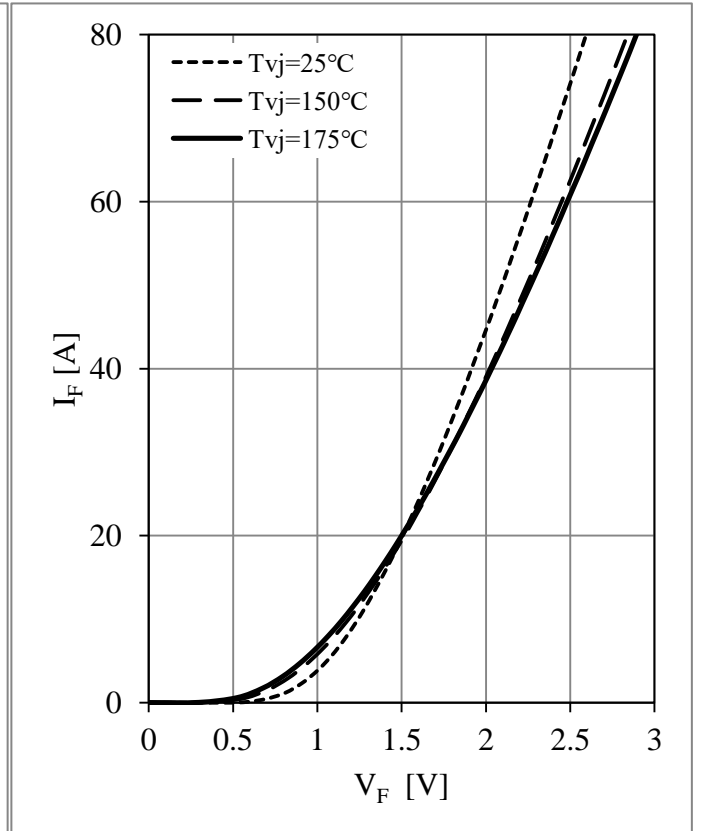

Fig 16. Diode Forward Characteristics

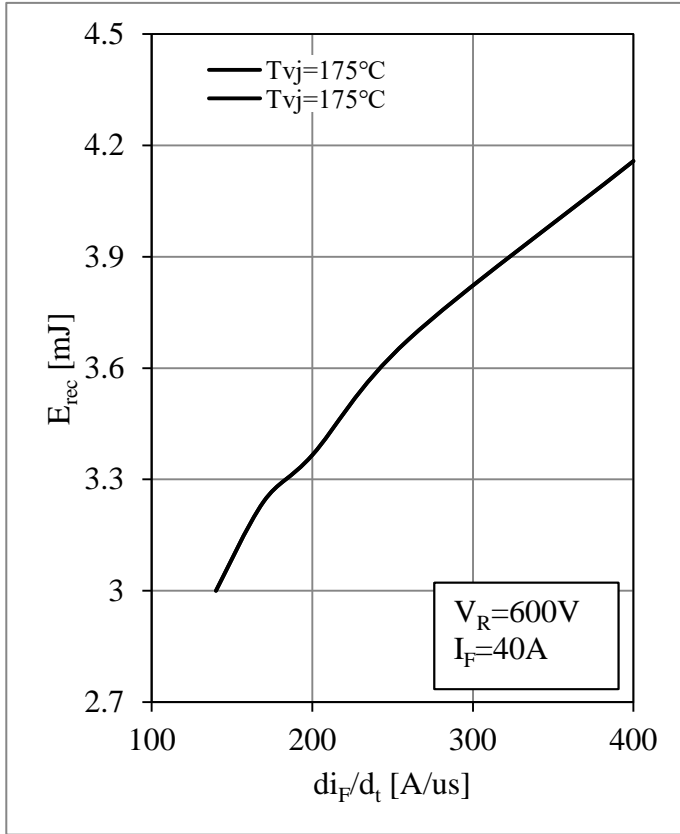

Fig 17. Reverse Recovery Time vs. di_F/d_t

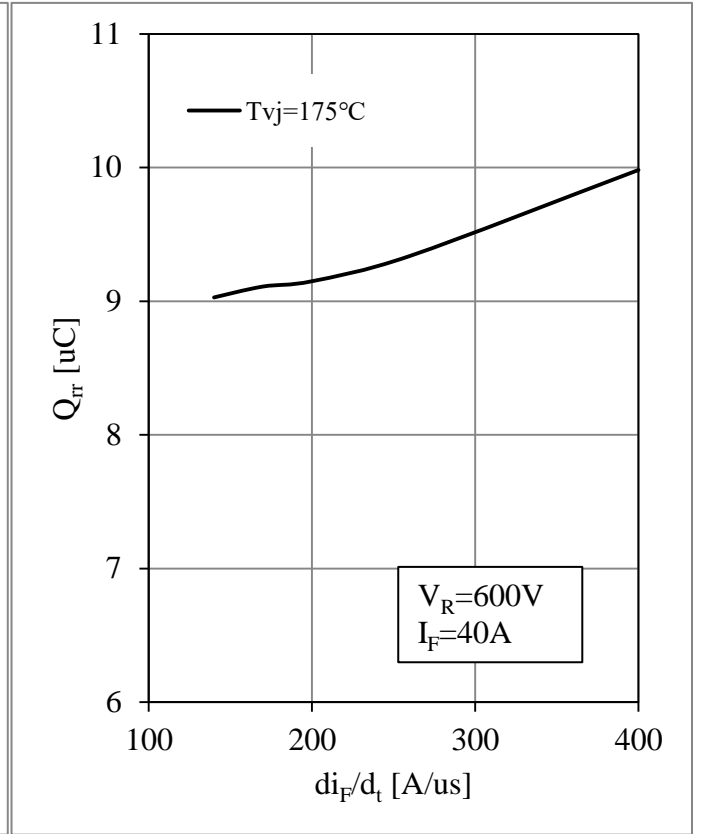

Fig 18. Reverse Recovery Charge vs. di_F/d_t

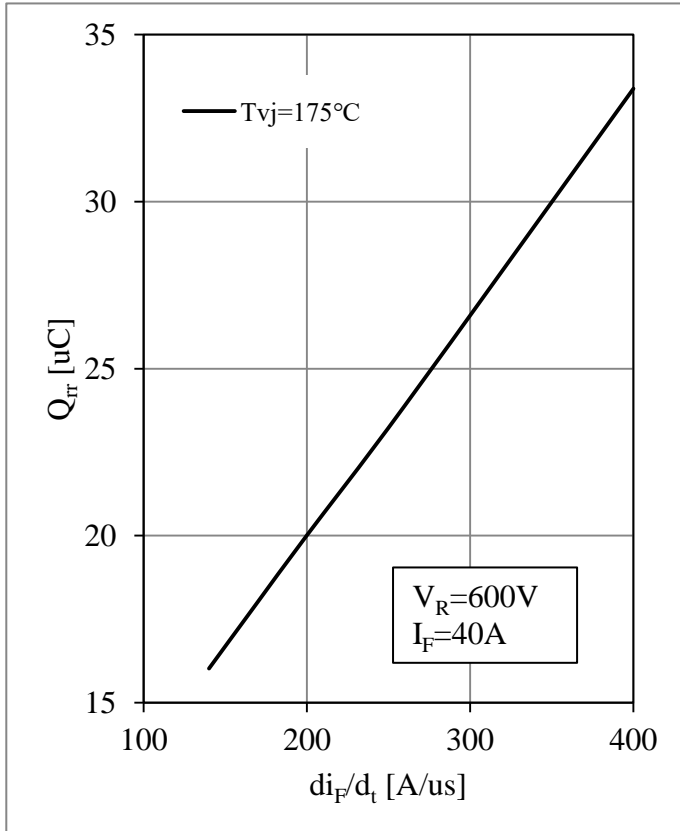

Fig 19. Reverse Recovery Current vs. di_F/d_t

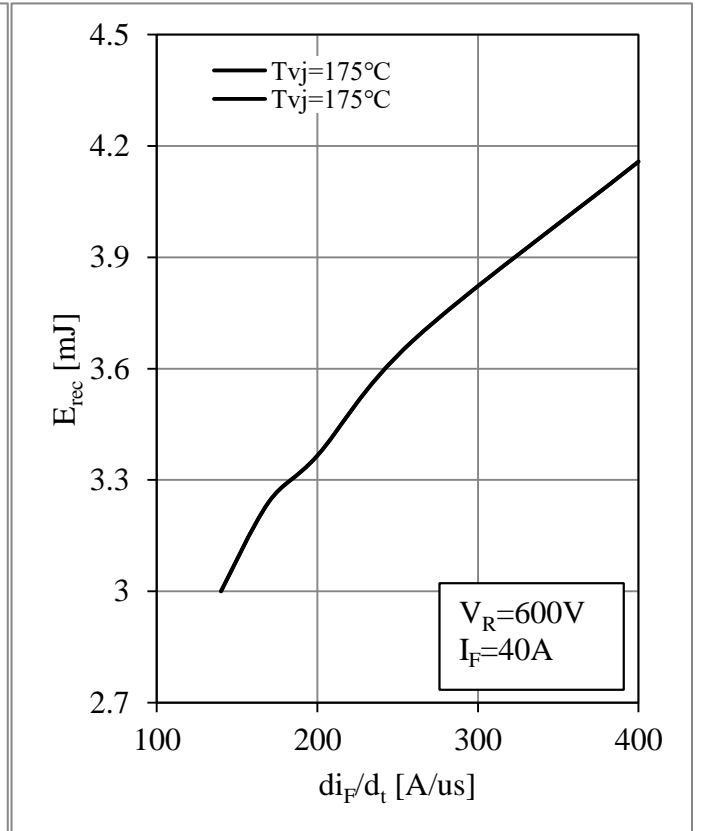

Fig 20. Reverse Energy Losses vs. di_F/d_t

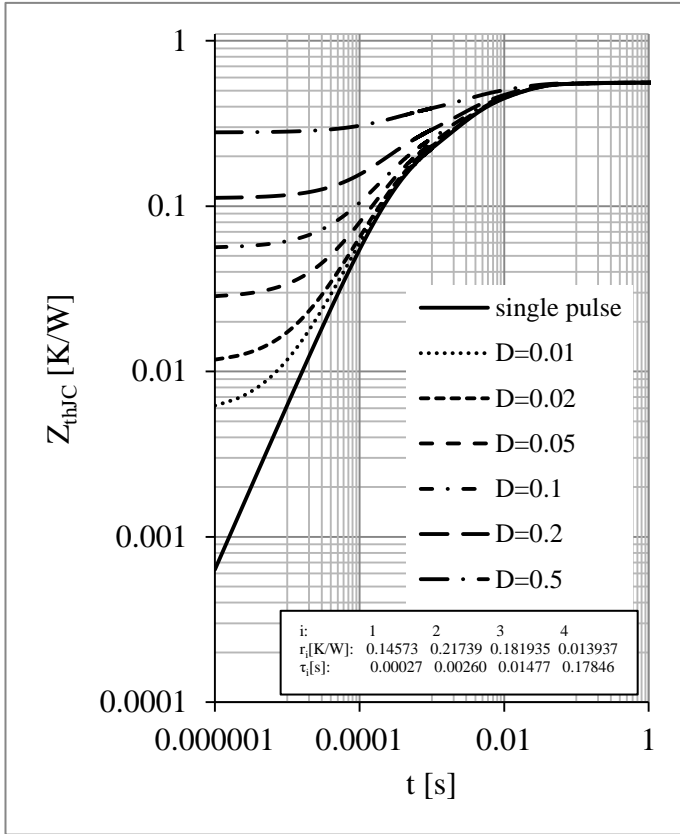
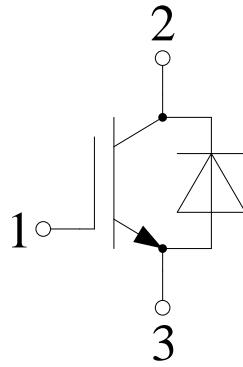

Fig 21. Diode Transient Thermal Impedance

Circuit Schematic



Package Dimensions

Dimensions in Millimeters

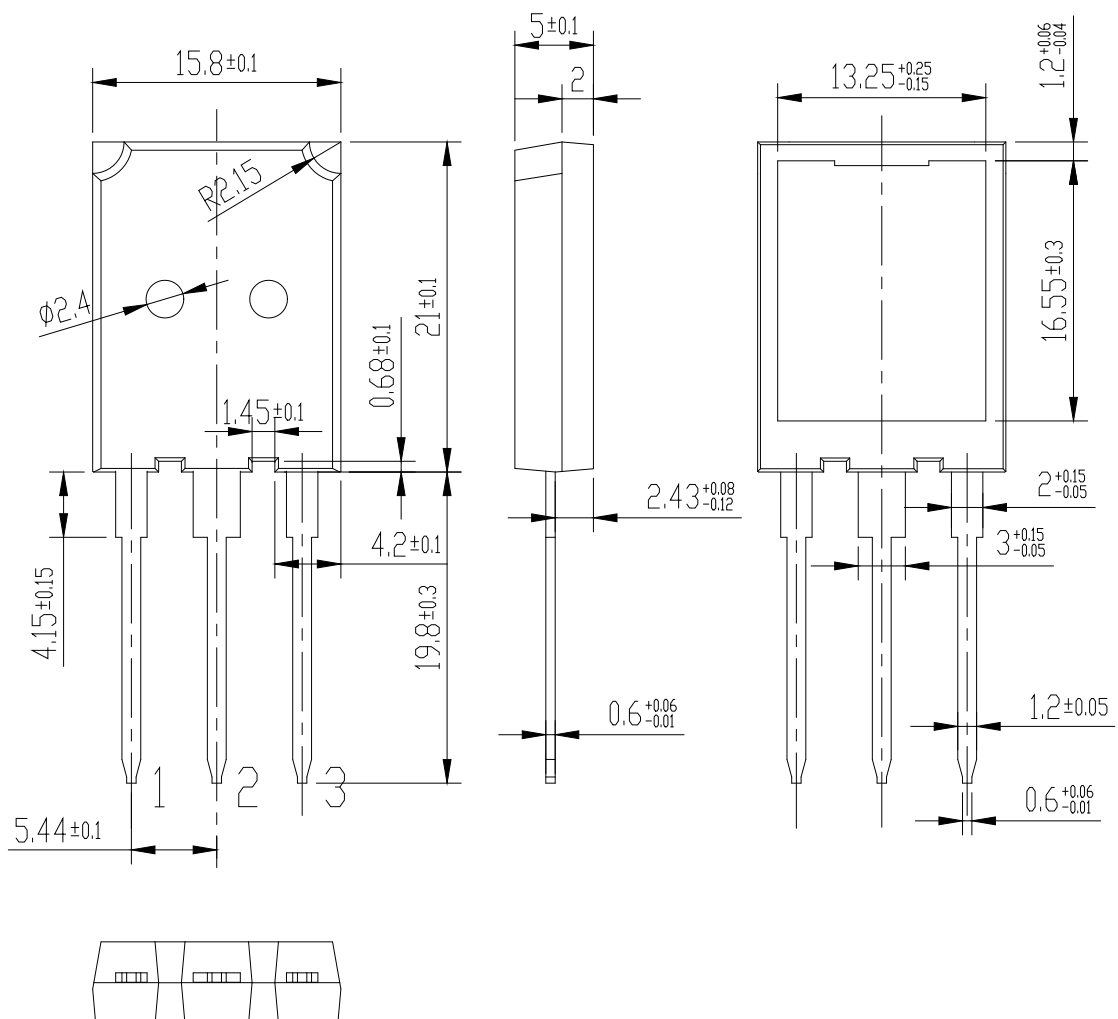

Terms and Conditions of Usage

The data contained in this product datasheet is exclusively intended for technically trained staff. you and your technical departments will have to evaluate the suitability of the product for the intended application and the completeness of the product data with respect to such application.

This product data sheet is describing the characteristics of this product for which a warranty is granted. Any such warranty is granted exclusively pursuant the terms and conditions of the supply agreement. There will be no guarantee of any kind for the product and its characteristics.

Should you require product information in excess of the data given in this product data sheet or which concerns the specific application of our product, please contact the sales office, which is responsible for you (see www.powersemi.cc), For those that are specifically interested we may provide application notes.

Due to technical requirements our product may contain dangerous substances. For information on the types in question please contact the sales office, which is responsible for you.

Should you intend to use the Product in aviation applications, in health or live endangering or life support applications, please notify.

If and to the extent necessary, please forward equivalent notices to your customers.
Changes of this product data sheet are reserved.