

Description

The DFS04FB12HDW1 is a 3 Phase SiC MOSFET Power Module. It integrates high performance SiC MOSFET chips for xEV or motor drives application.

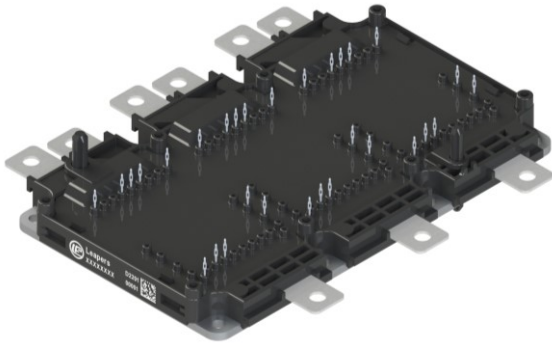

Features

- Blocking voltage 1200V
- $R_{DS(on)} = 4.2m\Omega$ ($T_j = 25^\circ C$)
- $R_{DS(on)} = 6.8m\Omega$ ($T_j = 175^\circ C$)
- Arcbonding™ technology
- 175°C maximum junction temperature
- Si₃N₄ AMB substrate
- Direct Cooled Pin Fin Base Plate
- Thermistor inside
- Press FIT Contact Technology

Applications

- xEV Applications
- Motor Drives

Circuit diagram

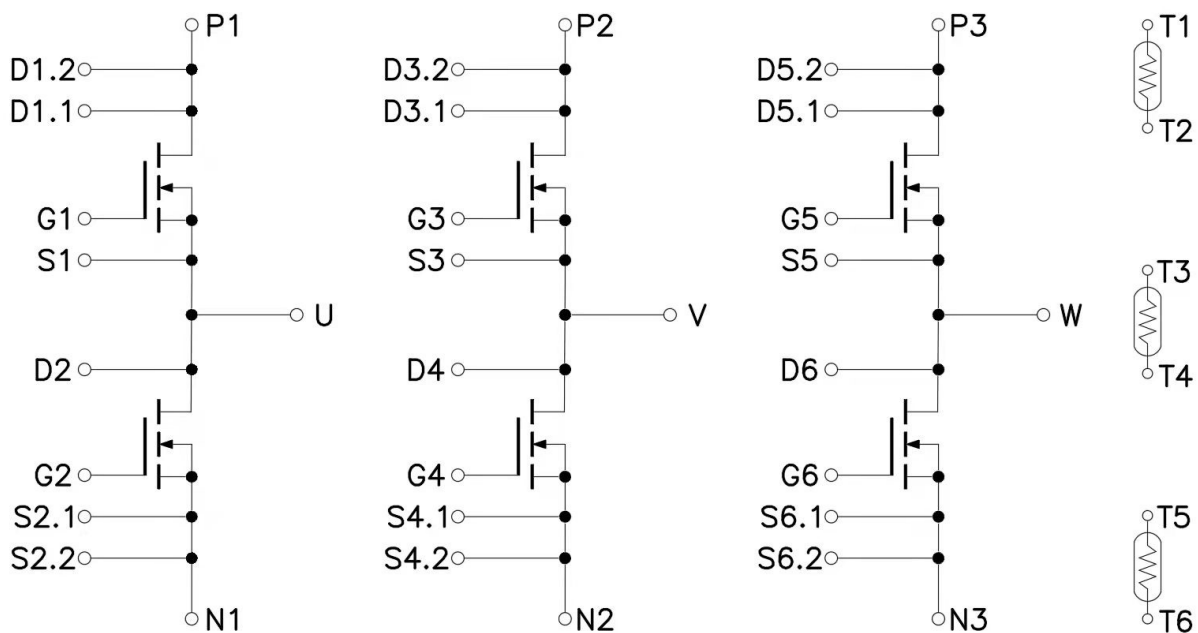

Figure 1. Out drawing & circuit diagram for DFS04FB12HDW1

Maximum Ratings ($T_j=25^\circ\text{C}$ unless otherwise specified)

Symbol	Parameter	Conditions	Ratings	Unit
V_{DSS}	Drain-Source Voltage	G-S Short	1200	V
V_{GSS}	Gate-Source Voltage	D-S Short, AC frequency $\geq 1\text{Hz}$, Note1	-8V/+19V	V
I_{DS}	DC Continuous Drain Current	$T_f=25^\circ\text{C}$	375	A
I_{DS}	DC Continuous Drain Current	$T_f=65^\circ\text{C}$	320	A
I_{SD}	Source (Body Diode) Current	$T_f=25^\circ\text{C}$, with ON signal	375	A
I_{SD}	Source (Body Diode) Current	$T_f=65^\circ\text{C}$, with ON signal	320	A
I_{DP}	Drain Pulse Current, Peak	Less than 1ms, Note2	800	A
P_D	Maximum Power Dissipation	$T_f=25^\circ\text{C}$	962	W
T_j	junction temperature	-	-40 to 175	$^\circ\text{C}$
T_{stg}	Storage temperature	-	-40 to 125	$^\circ\text{C}$

Note1: Recommended Operating Value, -4V/+15V

Note2: Pulse width limited by maximum junction temperature

Typical current output ability

Condition: SPWM control, $V_{CC}=800\text{V}$, $R_g=4.5\Omega$, $T_f=65^\circ\text{C}$, $T_{jmax}=175^\circ\text{C}$, $\text{PF}=0.8$, Modulation rate =1

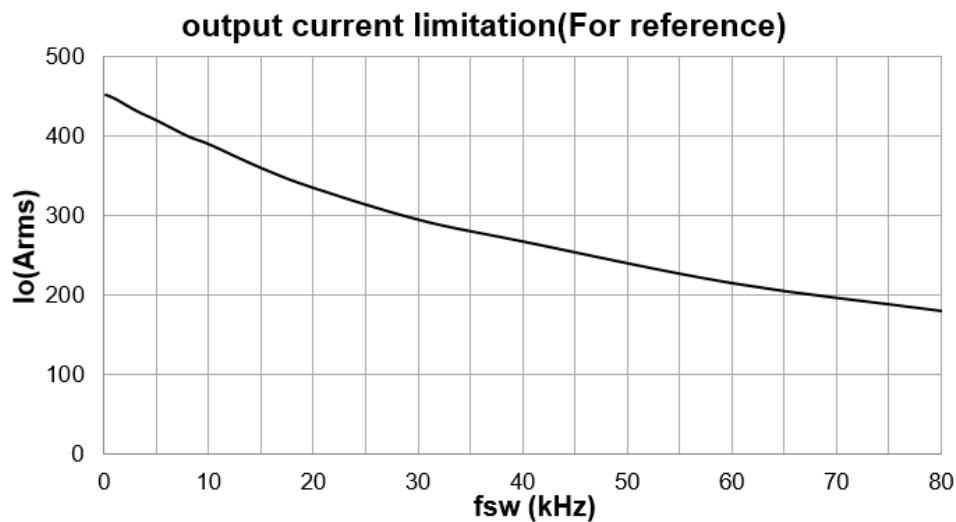

Note3: This graph is calculated value for reference based on the limitation of $T_{jmax}=175^\circ\text{C}$. The actual current out ability depends on inverter electrical, thermal and mechanic design. Please confirm it in actual application system.

Module

Parameter	Conditions	Value	Unit
Isolation voltage	Main terminal to base plate, f=0Hz, t=1sec	4.2	kV
Material of module baseplate	-	Cu+Ni	-
Creepage distance	terminal to heatsink terminal to terminal	9	mm
Clearance	terminal to heatsink terminal to terminal	4.5	mm
Stray inductance module	T _f =65°C	8	nH
Module lead resistance, terminals – chip	T _f =65°C	0.2	mΩ
Mounting torque for module mounting	Screw M4 baseplate to heatsink	1.8 to 2.2	Nm
Weight	-	798	g

NTC characteristics

Symbol	Parameter	Condition	Value			Unit
			Min.	Typ.	Max.	
R ₂₅	Resistance	T _c =25°C	-	5	-	kΩ
ΔR/R	Deviation of R ₁₀₀	T _c =100°C, R ₁₀₀ =493Ω	5	-	5	%
P ₂₅	Power dissipation	T _c =25°C	-	-	20	mW
B _{25/50}	B-value	R ₂ =R ₂₅ exp [B _{25/50} (1/T ₂ - 1/(298,15 K))]	-	3375	-	K
B _{25/80}	B-value	R ₂ =R ₂₅ exp [B _{25/80} (1/T ₂ - 1/(298,15 K))]	-	3411	-	K
B _{25/100}	B-value	R ₂ =R ₂₅ exp [B _{25/100} (1/T ₂ - 1/(298,15 K))]	-	3433	-	K

MOSFET Electrical characteristics ($T_j = 25^\circ\text{C}$ unless otherwise specified, chip)

Symbol	Item	Condition	Value			Unit	
			Min.	Typ.	Max		
$V_{(BR)DSS}$	Drain-Source Breakdown Voltage	$V_{GS} = 0V, I_D = 1mA$	1200	-	-	V	
I_{DSS}	Zero gate voltage drain current	$V_{DS} = 1200V, V_{GS} = 0V$	-	80	400	μA	
$V_{GS(th)}$	Gate-source threshold voltage	$I_D = 110mA, V_{DS} = V_{GS}$	1.8	2.5	3.6	V	
I_{GSS}	Gate-Source Leakage Current	$V_{GS} = 15V, V_{DS} = 0V, T_j = 25^\circ\text{C}$	-	0.04	10	μA	
$R_{DS(on)}$ (Chip)	Static drain-source	$I_D = 400A$	3	4.2	5.5	$m\Omega$	
	On-state resistance	$V_{GS} = 15V$					
$V_{DS(on)}$ (Chip)	Static drain-source	$I_D = 400A$	-	1.68	2.2	V	
	On-state voltage	$V_{GS} = 15V$					
C_{iss}	Input capacitance	$V_{DS} = 800V, V_{GS} = 0V$	-	22	-	nF	
C_{oss}	Output capacitance	$f = 100KHz, V_{ac} = 25mV$	-	0.8	-	nF	
C_{rss}	Reverse transfer capacitance		-	0.05	-	nF	
Q_G	Total gate charge	$V_{DD} = 800V, I_D = 400A, V_{GS} = -4/+15V$	-	760	-	nC	
$t_{d(on)}$	Turn-on delay time	$V_{DD} = 600V$ $I_D = 400A$ $V_{GS} = +15/-4V$ $R_G = 4.5\Omega$ Inductive load switching operation	$T_j = 25^\circ\text{C}$	-	138	-	ns
			$T_j = 150^\circ\text{C}$	-	122	-	
t_r	Rise time		$T_j = 25^\circ\text{C}$	-	88	-	ns
			$T_j = 150^\circ\text{C}$	-	82	-	
$t_{d(off)}$	Turn-off delay time		$T_j = 25^\circ\text{C}$	-	286	-	ns
			$T_j = 150^\circ\text{C}$	-	325	-	
t_f	Fall time		$T_j = 25^\circ\text{C}$	-	55	-	ns
			$T_j = 150^\circ\text{C}$	-	69	-	
E_{on}	Turn-on power dissipation		$T_j = 25^\circ\text{C}$	-	14.5	-	mJ
			$T_j = 150^\circ\text{C}$	-	15.6	-	
E_{off}	Turn-off power dissipation		$T_j = 25^\circ\text{C}$	-	15.7	-	mJ
			$T_j = 150^\circ\text{C}$	-	16.1	-	
$R_{th(j-f)}$	FET Thermal Resistance	Junction to cooling fluid $\Delta V/\Delta t = 10dm^3/min, T_f = 65^\circ\text{C}$	-	0.156	-	K/W	

Body Diode Electrical characteristics ($T_j=25^\circ\text{C}$ unless otherwise specified, chip)

Symbol	Item	Condition	Value			Unit	
			Min.	Typ.	Max.		
V_{SD}	Body Diode Forward Voltage	$V_{GS} = -4\text{V}$ $I_{SD} = 400\text{A}$	$T_j = 25^\circ\text{C}$	4.6	6.0	-	V
			$T_j = 175^\circ\text{C}$	4.2	5.5	-	
T_{rr}	Reverse recovery time	$V_{DD} = 600\text{V}$ $I_D = 400\text{A}$	$T_j = 25^\circ\text{C}$	-	35	-	ns
			$T_j = 150^\circ\text{C}$	-	60	-	
Q_{rr}	Reverse recovery charge	$V_{GS} = +15/-4\text{V}$ $R_G = 4.5\Omega$	$T_j = 25^\circ\text{C}$	-	1.73	-	uC
			$T_j = 150^\circ\text{C}$	-	5.6	-	
E_{rr}	Diode switching power dissipation	Inductive load switching operation	$T_j = 25^\circ\text{C}$	-	0.40	-	mJ
			$T_j = 150^\circ\text{C}$	-	1.32	-	

Test Conditions

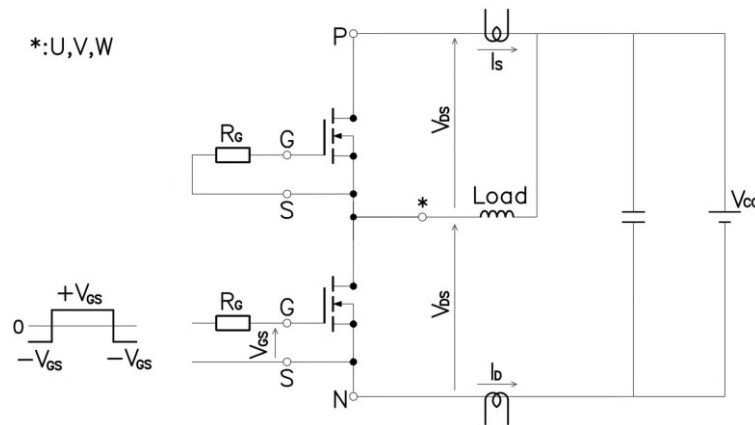

Figure 3. Switching time measure circuit

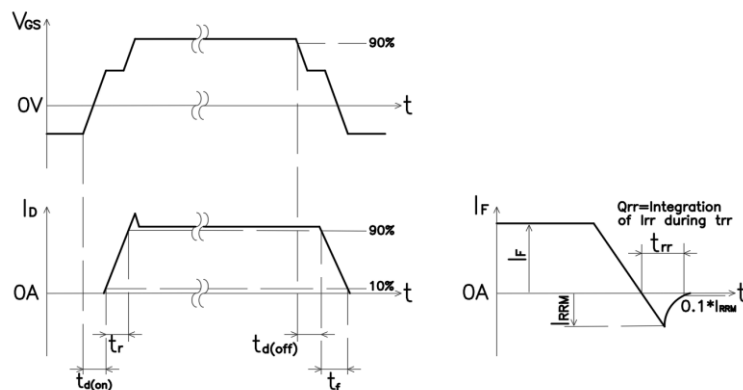

Figure 4. Switching time definition

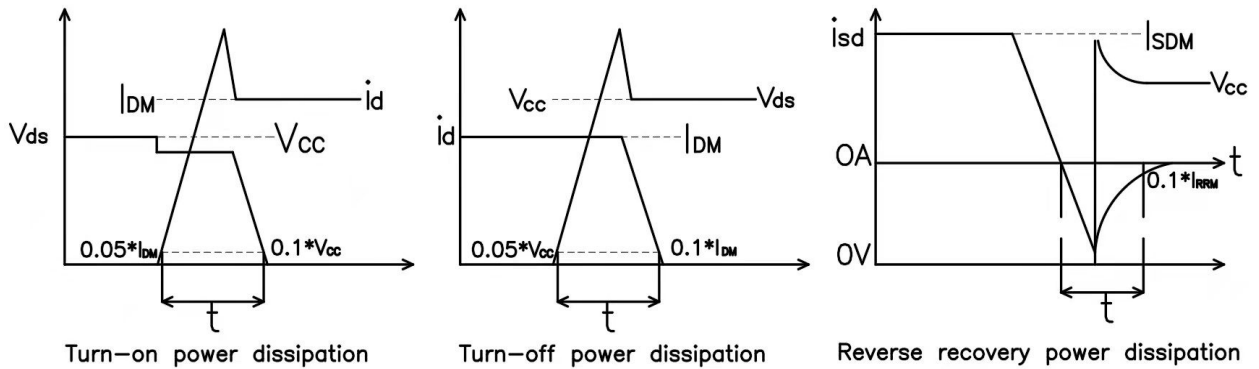

Figure 5. Switching power dissipation definition

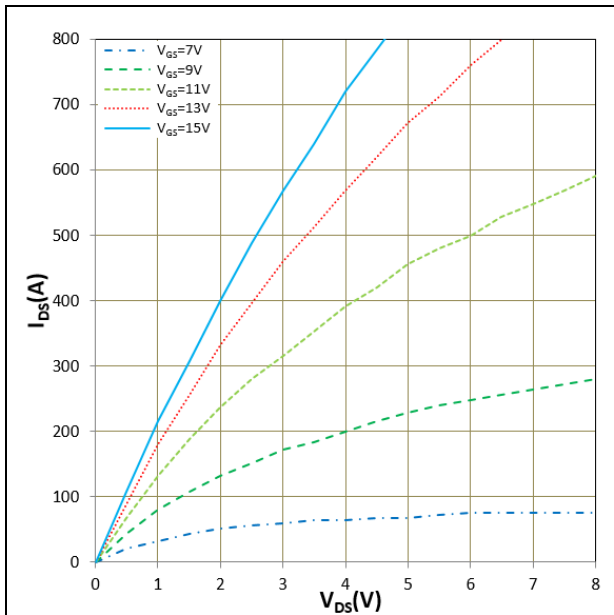

Figure 6. I_{DS} vs V_{DS}
 $T_j = 25^\circ\text{C}$, V_{GS} parameter

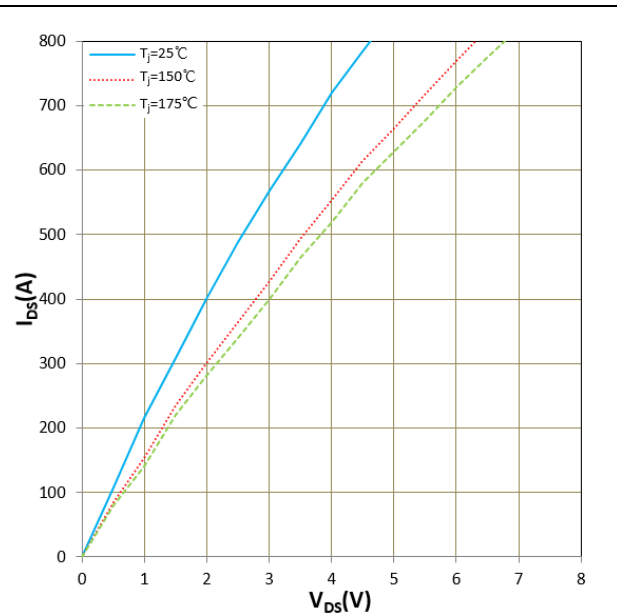

Figure 7. I_{DS} vs V_{DS}
 $V_{GS} = 15\text{V}$, T_j parameter

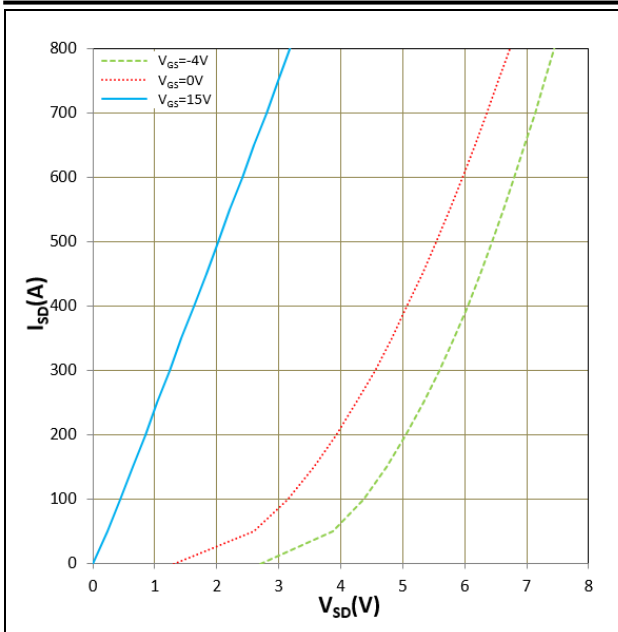

Figure 8. I_{SD} vs V_{SD}
 $T_j = 25^\circ\text{C}$, V_{GS} parameter

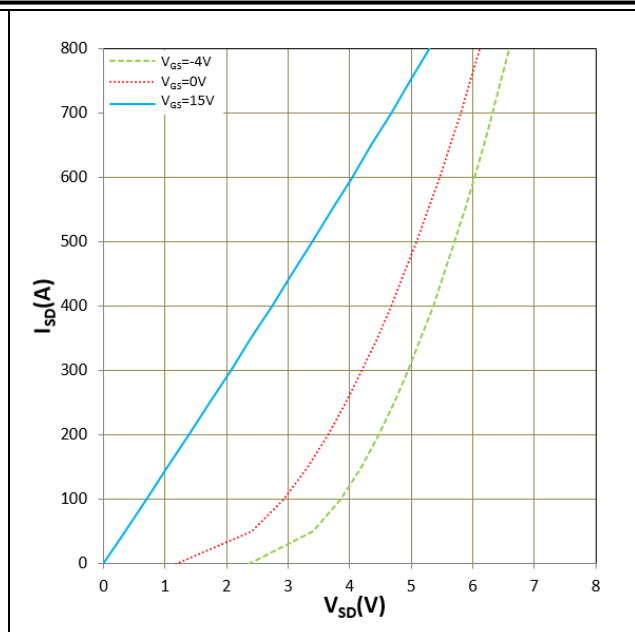

Figure 9. I_{SD} vs V_{SD}
 $T_j = 175^\circ\text{C}$, V_{GS} parameter

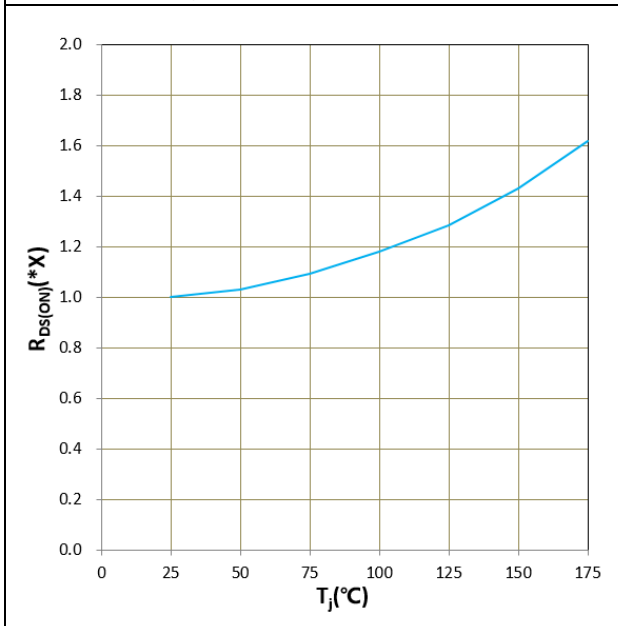

Figure 10. $R_{DS(ON)}$ vs T_j
 $1.0x = 4.2\text{m}\Omega$, $I_D = 400\text{A}$

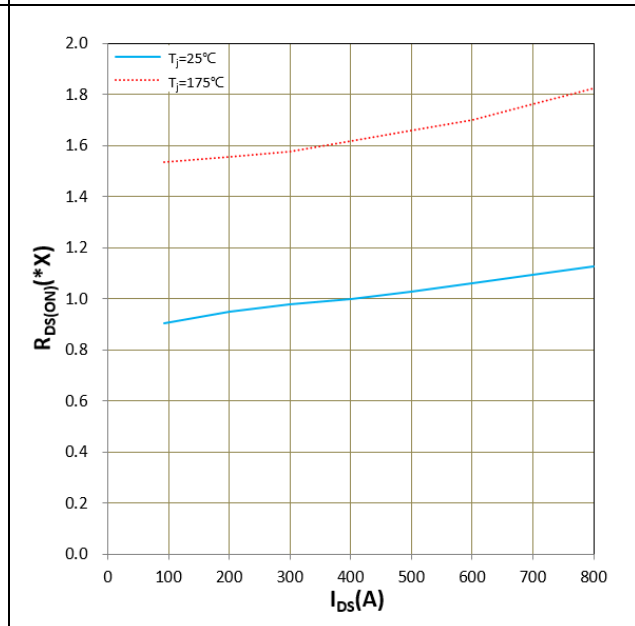

Figure 11. $R_{DS(ON)}$ vs I_{DS}
 $1.0x = 4.2\text{m}\Omega$

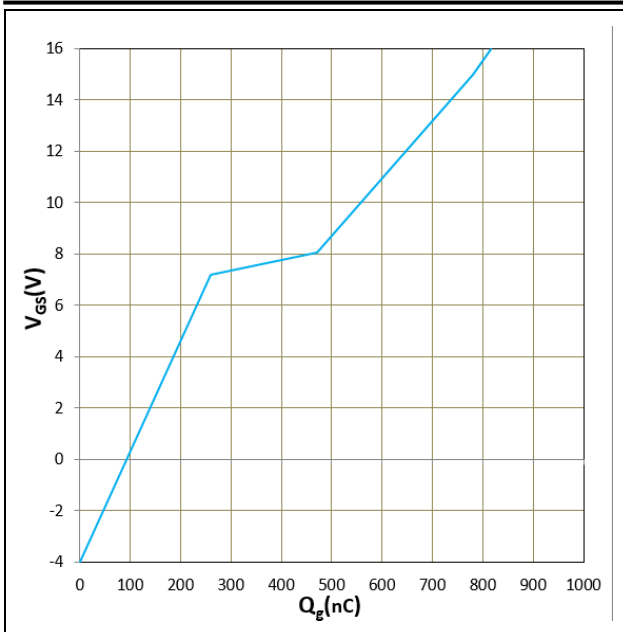

Figure 12. V_{GS} vs Q_g
 $T_j = 25^\circ\text{C}$, $V_{CC} = 800\text{V}$, $I_D = 400\text{A}$

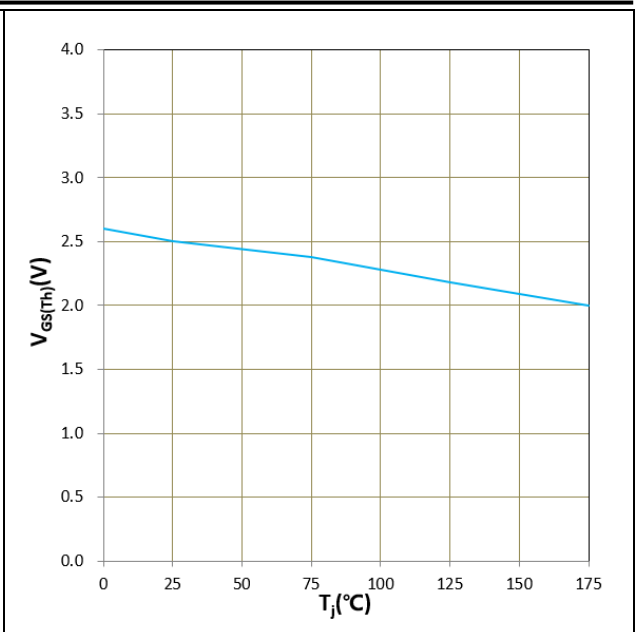

Figure 13. $V_{GS(th)}$ vs T_j
 $V_{GS} = V_{DS}$, $I_D = 110\text{mA}$

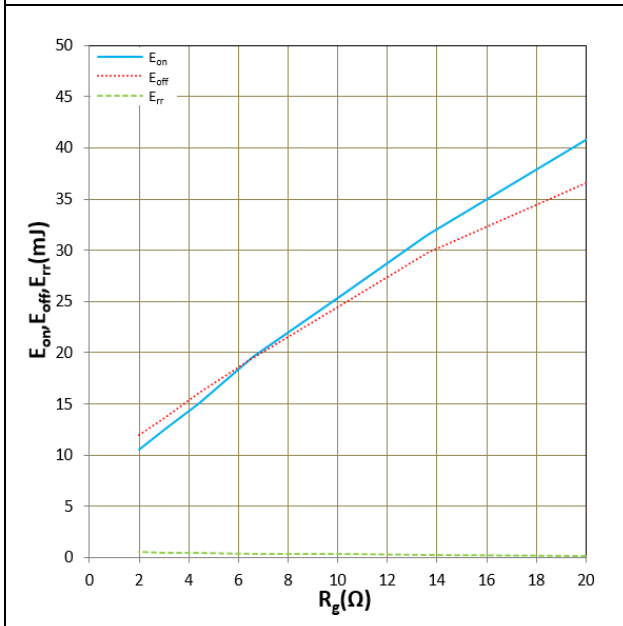

Figure 14. E_{on}, E_{off}, E_{rr} vs R_g
 $T_j = 25^\circ\text{C}$, $V_{CC} = 600\text{V}$, $I_D = 400\text{A}$, $V_{GS} = +15\text{V}/-4\text{V}$
 Inductive Load

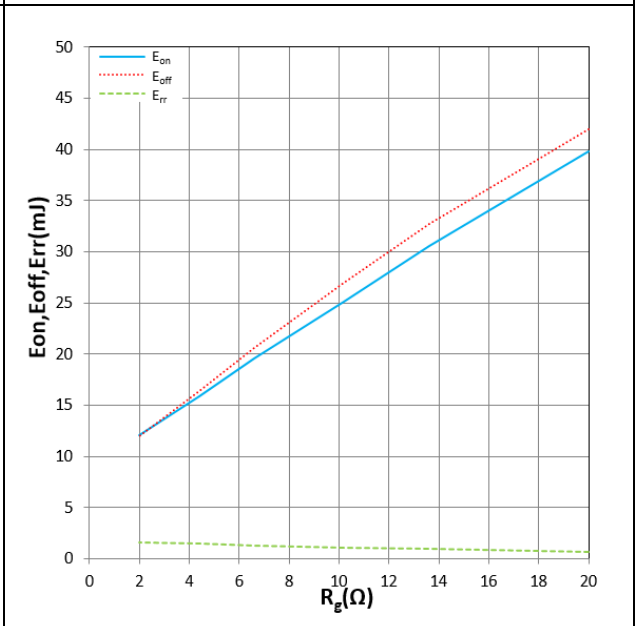

Figure 15. E_{on}, E_{off}, E_{rr} vs R_g
 $T_j = 150^\circ\text{C}$, $V_{CC} = 600\text{V}$, $I_D = 400\text{A}$, $V_{GS} = +15\text{V}/-4\text{V}$
 Inductive Load

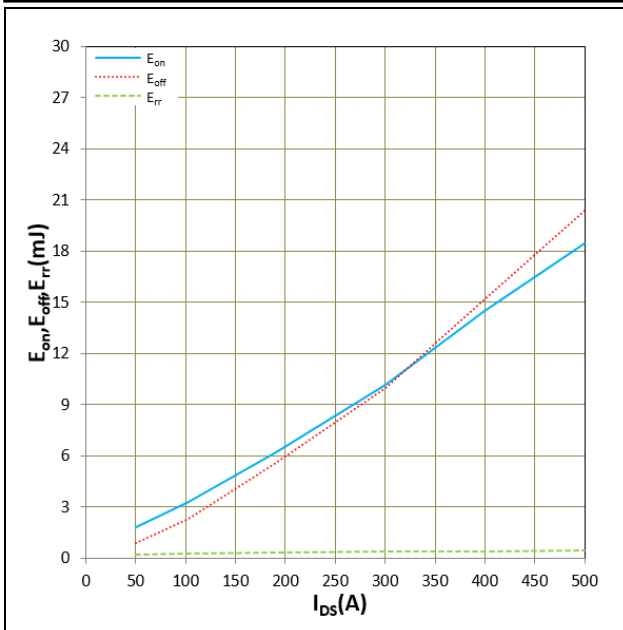

Figure 16. E_{on} , E_{off} , E_{rr} vs I_{DS}
 $T_j = 25^\circ\text{C}$, $V_{CC} = 600\text{V}$, $R_G = 4.5\Omega$, $V_{GS} = +15\text{V}/-4\text{V}$
 Inductive Load

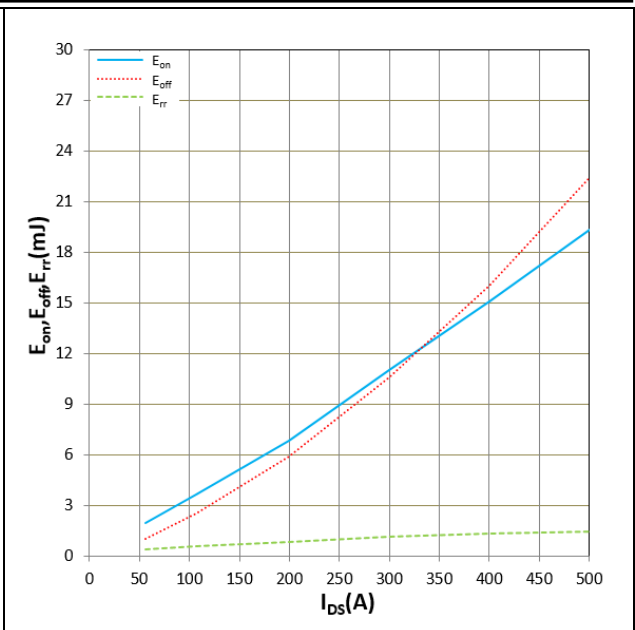

Figure 17. E_{on} , E_{off} , E_{rr} vs I_{DS}
 $T_j = 150^\circ\text{C}$, $V_{CC} = 600\text{V}$, $R_G = 4.5\Omega$, $V_{GS} = +15\text{V}/-4\text{V}$
 Inductive Load

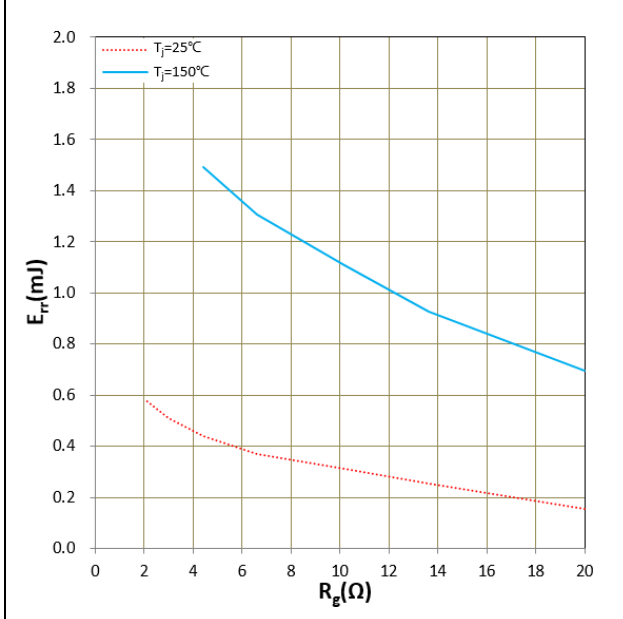

Figure 18. E_{rr} vs R_G
 $V_{DD} = 600\text{V}$, $I_F = 400\text{A}$, $V_{GS} = +15\text{V}/-4\text{V}$
 Inductive Load

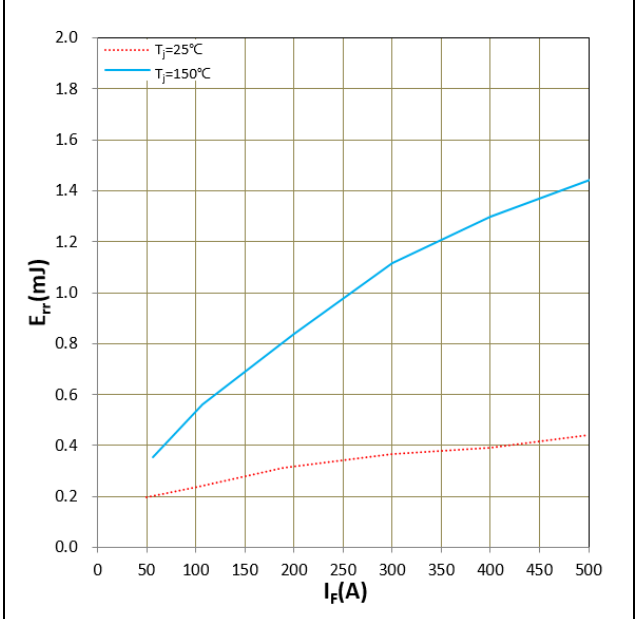

Figure 19. E_{rr} vs I_F
 $V_{DD} = 600\text{V}$, $R_G = 4.5\Omega$, $V_{GS} = +15\text{V}/-4\text{V}$
 Inductive Load

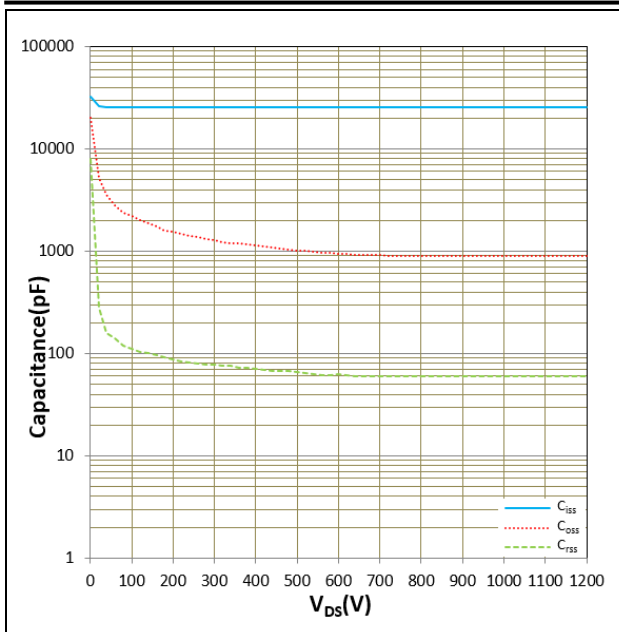

Figure 20. $C_{iss}, C_{oss}, C_{rss}$ vs V_{DS}
 $T_j = 25^\circ\text{C}$

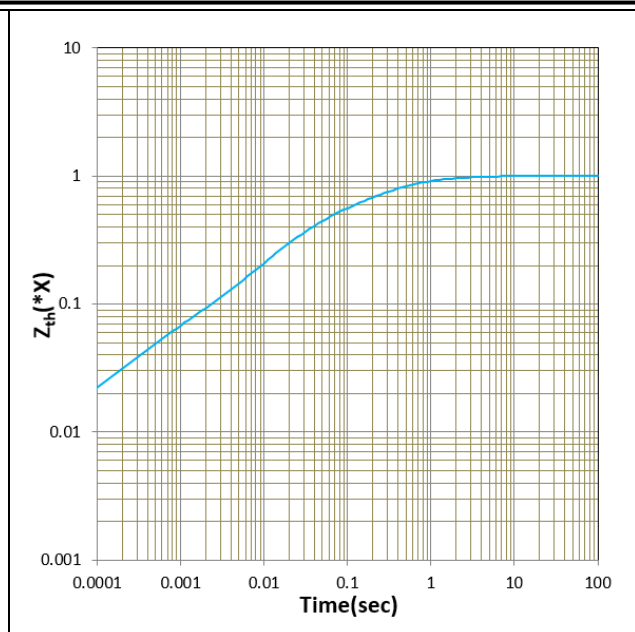

Figure 21. Transient thermal impedance
 $1.0x = 0.156\text{K/W}$

IMPORTANT NOTICE

This product data sheet describes the characteristics of this product for which a warranty is granted. Any such warranty is granted exclusively under the terms and conditions of the supply agreement. There will be no guarantee or of any kind for the product and its characteristics.

The data contained in this document is exclusively intended for technically trained staff. You and your technical departments will have to evaluate the product's suitability for the intended application and the completeness of the product data concerning such application.

Due to technical requirements, our product may contain dangerous substances. For information on the types in question, please contact the sales staff responsible for you.

Changes to this product data sheet are reserved.

Please contact the sales staff (Sales@leapers-power.com) for further information on the product, technology, delivery terms, conditions and prices.