



Approval & Compliance



Features

- Rated current : 1A-10A

- Small size, easy to install

- AC power socket input

- Can be customized upon request

Applications

- Animation entertainment equipment

- Small and medium machine

- All kinds of fitness equipment

- All kinds of automatic control equipment

- Portable electrical and electronic equipment

Product information

IEC Socket type power filter-DAI1

Performance Indicator

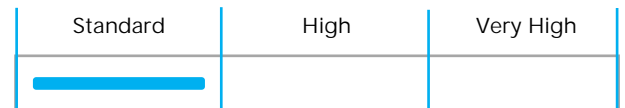

Rated Current [A]

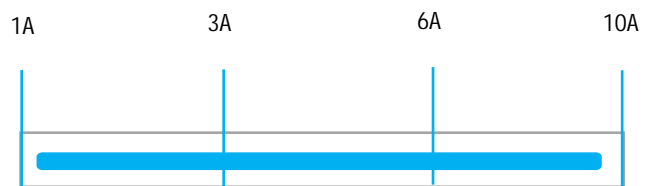

Description

Small size, easy installation, parameters can be customized, with strong anti-interference, high performance characteristics, AC power socket input, 6.3x0.8 chip output connection.

Technical Data

Rated Voltage	115/250VAC
Line Frequency	50/60Hz
Test Voltage	1500VDC (line/line) 2150VAC (line/ground)
Insulation Resistance	>50M @500VDC
Temperature Rise	<30
Climatic Category	25/085/21
Housing Material	Nickel-plated iron

Typical Circuit Diagram

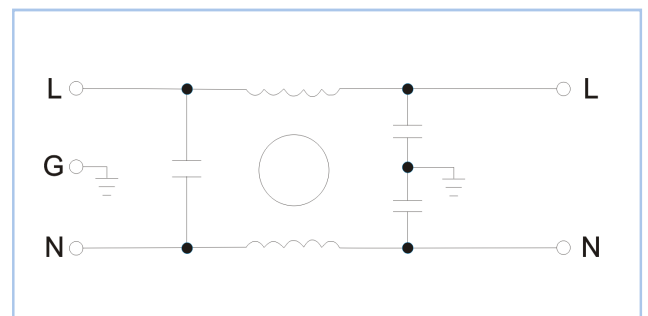

Part No	Rated Current	Rated Current	Case Type	Termination		Safety Certification	Remark
				Input	Output		
DAI1-1A	1A	<0.5mA	I1	Socket	Terminal	cUL, CE, ROHS	Parameter customization
DAI1-3A	3A	<0.5mA	I1	Socket	Terminal		
DAI1-6A	6A	<0.5mA	I1	Socket	Terminal		
DAI1-10A	10A	<0.5mA	I1	Socket	Terminal		

Overall Dimension (±1mm)

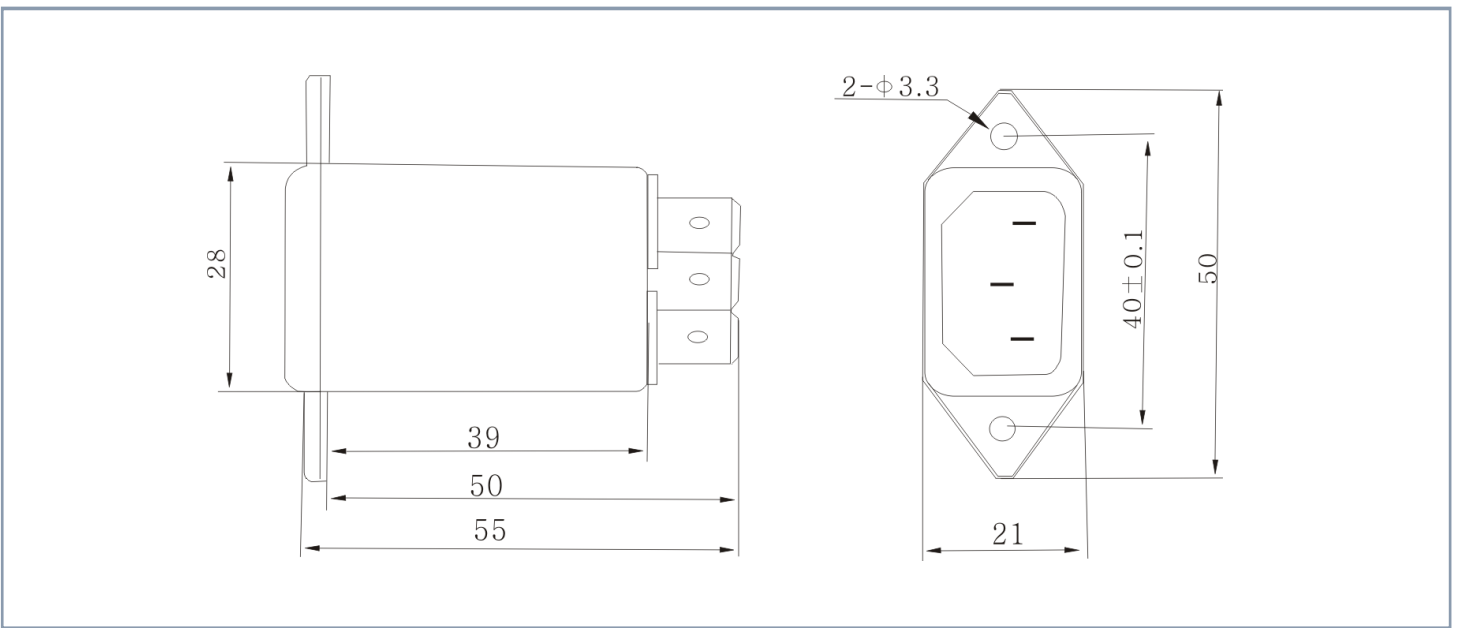

Insertion loss -(common mode)

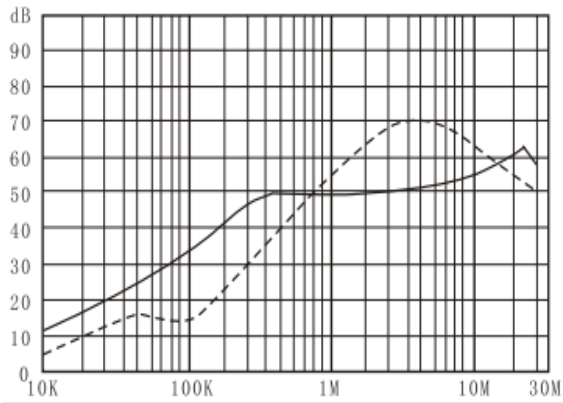

DAI1-1A

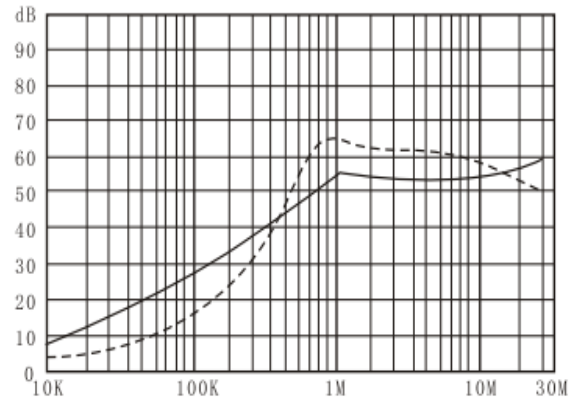

DAI1-3A

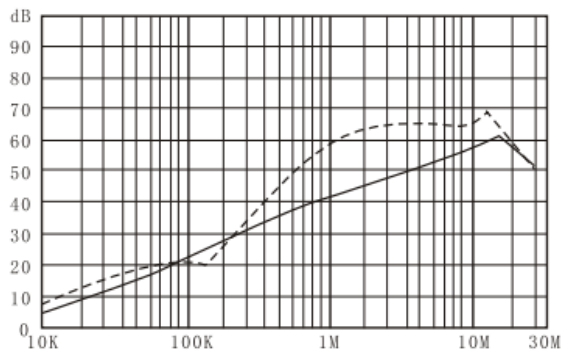

DAI1-6A

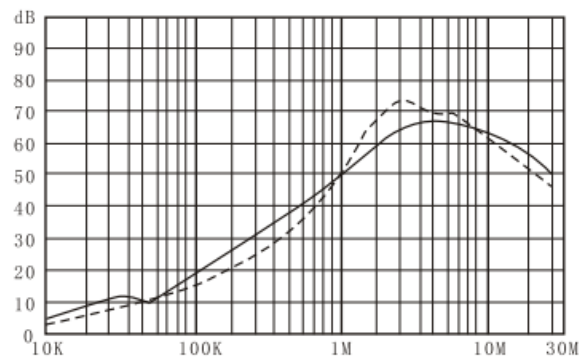

DAI1-10A