

## Schottky Diodes

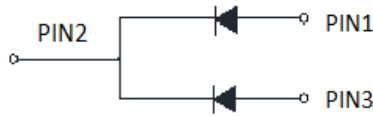
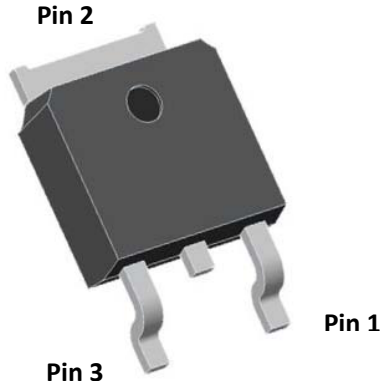

### Features

- High frequency operation
- High purity, high temperature epoxy encapsulation for enhanced mechanical strength and moisture resistance
- Guard ring for enhanced ruggedness and long term reliability
- Part no. with suffix "Q" means AEC-Q101 qualified

### Typical Applications

Typical applications are in switching power supplies, converters, automotive, freewheeling diodes, and reverse battery protection.

### Mechanical Data

- **Package:** TO-252  
Molding compound meets UL 94 V-0 flammability rating, RoHS-compliant, halogen free
- **Terminals:** Tin plated leads, solderable per J-STD-002 and JESD22-B102
- **Polarity:** As marked

### ■Maximum Ratings (T<sub>a</sub>=25°C Unless otherwise specified)

PARAMETER	SYMBOL	UNIT	MBR1060CDQ
Device marking code	-	-	MBR1060CD
Repetitive peak reverse voltage	V <sub>RRM</sub>	V	60
Average Rectified Output Current @60Hz -sine wave, T <sub>C</sub> =100°C	I <sub>O</sub>	A	10
Forward Surge Current (Non-repetitive) @60Hz Half-sine wave, 1 cycle, T <sub>a</sub> =25°C	I <sub>FSM</sub>	A	120
Current Squared Time @1ms≤t≤8.3ms T <sub>J</sub> =25°C	I <sup>2</sup> t	A <sup>2</sup> s	60
Storage Temperature	T <sub>stg</sub>	°C	-55 ~ +150
Junction Temperature	T <sub>J</sub>	°C	-55 ~ +150

### ■Electrical Characteristics (T<sub>a</sub>=25°C Unless otherwise specified)

PARAMETER	SYMBOL	UNIT	TEST CONDITIONS	Typ	Max	
Instantaneous forward voltage per diode	V <sub>F</sub>	V	I <sub>F</sub> =5A	T <sub>J</sub> =25°C	0.67	0.72
				T <sub>J</sub> =125°C	0.57	0.62
Typical junction capacitance per diode	C <sub>J</sub>	pF	V <sub>R</sub> =4V, f=1 MHz	235	-	
Instantaneous reverse current per diode	I <sub>R</sub>	mA	V <sub>R</sub> =60V	T <sub>J</sub> =25°C	-	0.1
				T <sub>J</sub> =125°C	-	20

### ■Thermal Characteristics (T<sub>a</sub>=25°C Unless otherwise specified)

PARAMETER	SYMBOL	UNIT	MBR1060CDQ	
Typical thermal resistance per diode	Between junction and case	R <sub>θJ-C</sub>	°C/W	5



# MBR1060CDQ

## ■ Characteristics (Typical)

Fig.1: Forward Current Derating Curve

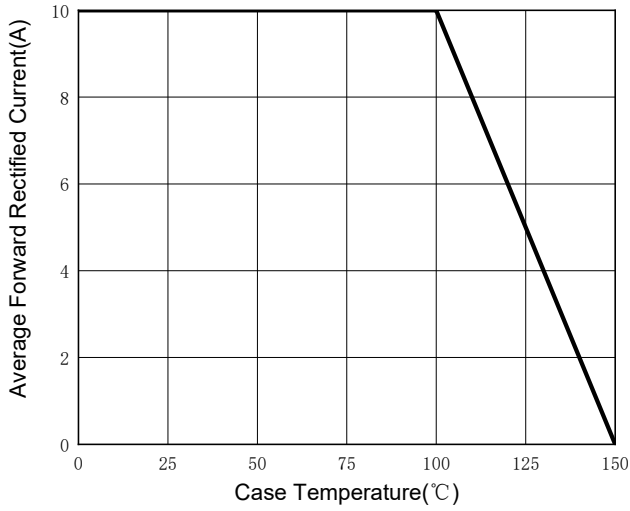

Fig.2: Forward Surge Current Capability( Per Diode)

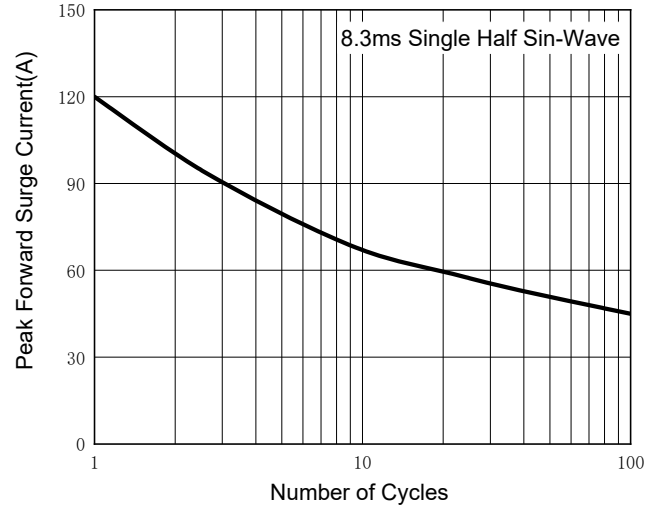

Fig.3: Typical Instantaneous Forward Characteristics( Per Diode)

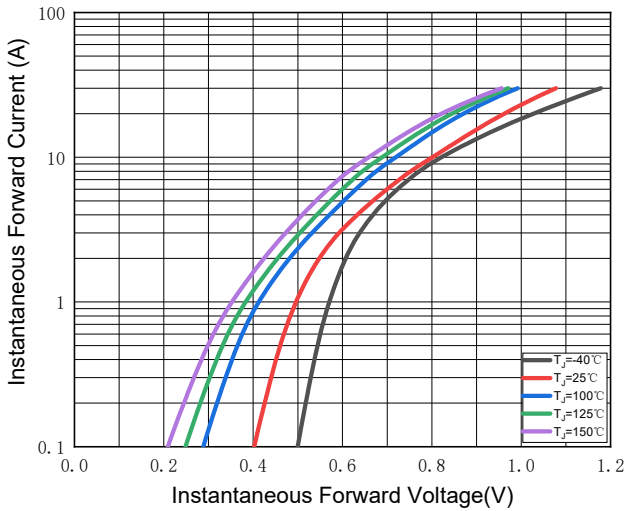

Fig.4: Typical Reverse Leakage Characteristics( Per Diode)

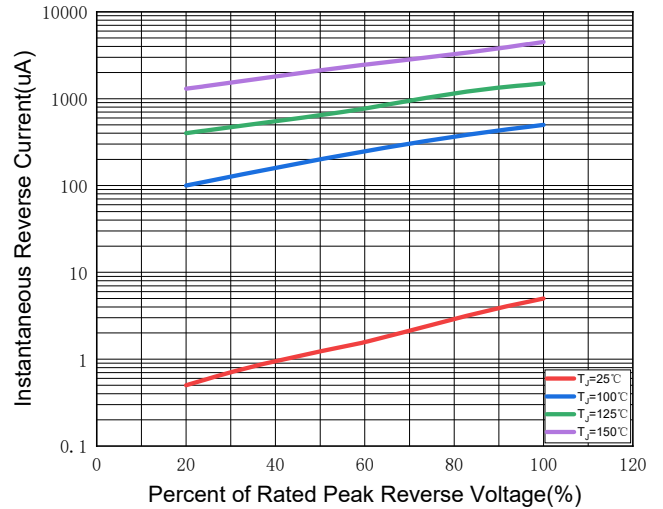
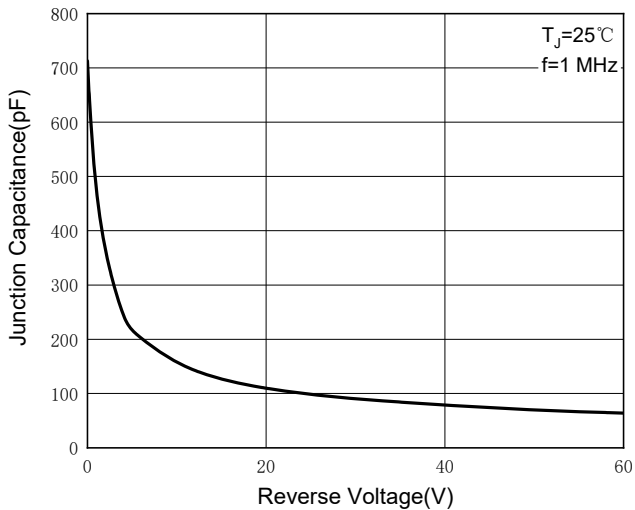

Fig.5: Typical Junction Capacitance(Per Diode)





# MBR1060CDQ

## Ordering Information (Example)

PREFERRED P/N	UNIT WEIGHT(g)	MINIIMUM PACKAGE(pcs)	INNER BOX QUANTITY(pcs)	OUTER CARTON QUANTITY(pcs)	DELIVERY MODE
MBR1060CDQ	Approximate 0.32	2500	2500	25000	Reel

## Outline Dimensions

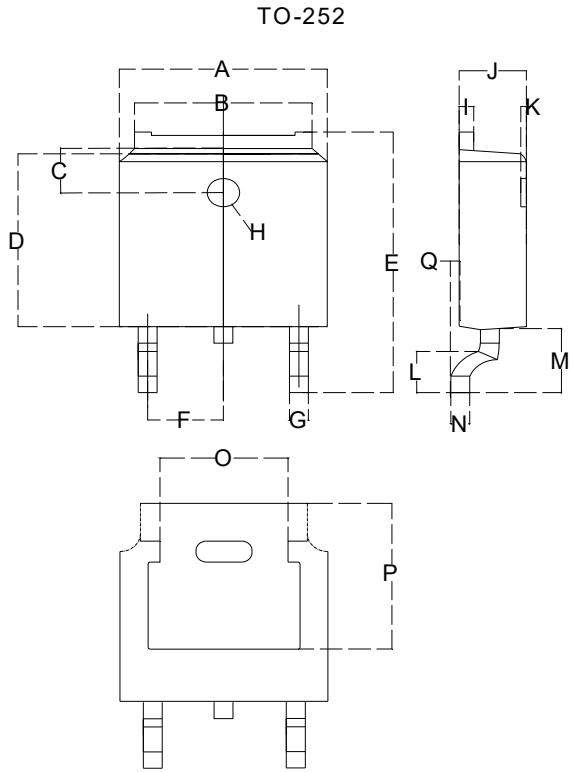

TO-252		
Dim	Min	Max
A	6.500	6.700
B	5.100	5.460
C	1.400	1.800
D	6.000	6.200
E	10.000	10.400
F	2.166	2.366
G	0.660	0.860
H	Φ 1.050	Φ 1.350
I	0.460	0.580
J	2.200	2.400
K	0	0.300
L	0.890	2.290
M	2.730	3.080
N	0.430	0.580
O	4.20	4.95
P	5.15	5.45
Q	0	0.2

Dimensions in millimeters

## Suggested Pad Layout

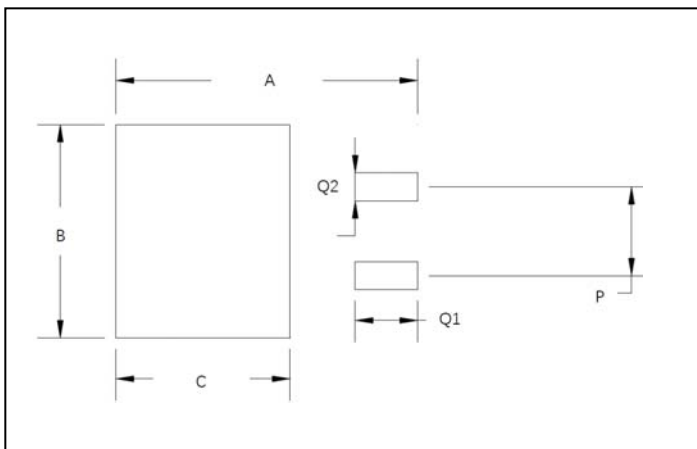

Dim	Millimeters
A	11.4
B	6.74
C	6.23
P	4.56
Q1	2.28
Q2	1.52



## MBR1060CDQ

---

### Disclaimer

The information presented in this document is for reference only. Yangzhou Yangjie Electronic Technology Co., Ltd. reserves the right to make changes without notice for the specification of the products displayed herein to improve reliability, function or design or otherwise.

The product listed herein is designed to be used with automotive electronics, are not designed for use in medical, lifesaving, lifesustaining, or military, Yangjie or anyone on its behalf, assumes no responsibility or liability for any damages resulting from such improper use of sale.

This publication supersedes & replaces all information previously supplied. For additional information, please visit our website [http:// www.21yangjie.com](http://www.21yangjie.com) , or consult your nearest Yangjie's sales office for further assistance.