

Surface Mount Schottky Rectifier



Features

- Guard ring for overvoltage protection
- Low power losses
- Extremely fast switching
- High forward surge capability
- High frequency operation
- Meets MSL level 1, per J-STD-020, LF maximum peak of 260 °C
- Part no. with suffix "Q" means AEC-Q101 qualified

Typical Applications

For use in low voltage high frequency inverters, freewheeling, DC/DC converters, automotive and polarity protection applications.

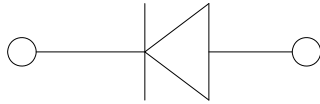

Mechanical Data

- **Package:** SOD-123FL
Molding compound meets UL 94 V-0 flammability rating, RoHS-compliant, halogen-free
- **Terminals:** Tin plated leads, solderable per J-STD-002 and JESD22-B102
- **Polarity:** Cathode line denotes the cathode end

■ Maximum Ratings (T_a=25°C Unless otherwise specified)

PARAMETER	SYMBOL	UNIT	S315Q	S320Q
Device marking code			S315	S320
Repetitive peak reverse voltage	V _{RRM}	V	150	200
Maximum RMS voltage	V _{RMS}	V	105	140
Maximum DC blocking voltage	V _{DC}	V	150	200
Maximum average forward rectified current at T _L (Fig.1)	I _O	A	3.0	
Surge(non-repetitive)forward current @60Hz half-sine wave,1 cycle, T _J =25°C	I _{FSM}	A	80	
Voltage rate of change (rated V _R)	dV/dt	V/μs	10000	
Storage temperature	T _{stg}	°C	-55 ~+175	
Junction temperature	T _J	°C	-55 ~+175	

■ Electrical Characteristics (T_a=25°C Unless otherwise specified)

PARAMETER	SYMBOL	TEST CONDITIONS	TYP	MAX	UNIT	
Instantaneous forward voltage	V _F	I _F =3A	T _J =25°C	0.81	0.9	V
			T _J =125°C	0.68	0.75	
Reverse current	I _R	Rated V _R	T _J =25°C	-	1	μA
			T _J =125°C	-	150	
Typical junction capacitance	C _J	V _R =4V,f=1MHz	60	-	pF	



S315Q THRU S320Q

■ Thermal Characteristics (Ta=25°C Unless otherwise specified)

PARAMETER	SYMBOL	UNIT	S315Q	S320Q
Thermal Resistance	$R_{\theta J-A}$	°C/W	85 ⁽¹⁾	
	$R_{\theta J-L}$		35 ⁽¹⁾	

Note:

(1) Thermal resistance from junction to ambient and from junction to lead mounted on P.C.B. with 3 mm x 3mm copper pad areas

■ Characteristics(Typical)

Fig.1:Forward Current Derating Curve

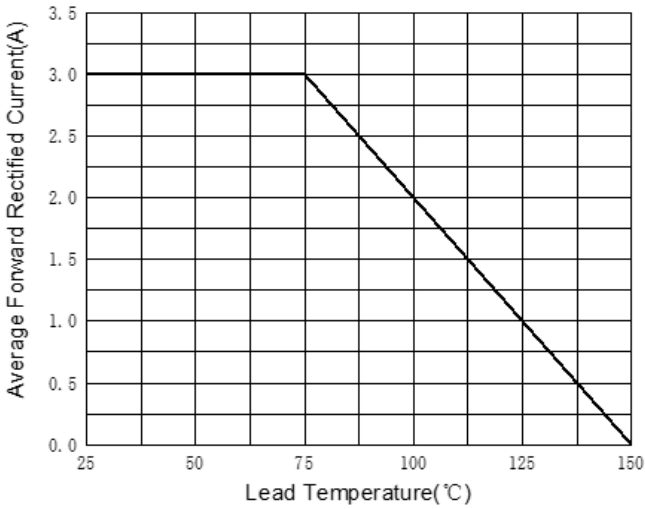

Fig.2:Maximum Non-Repetitive Peak Forward Surge Current

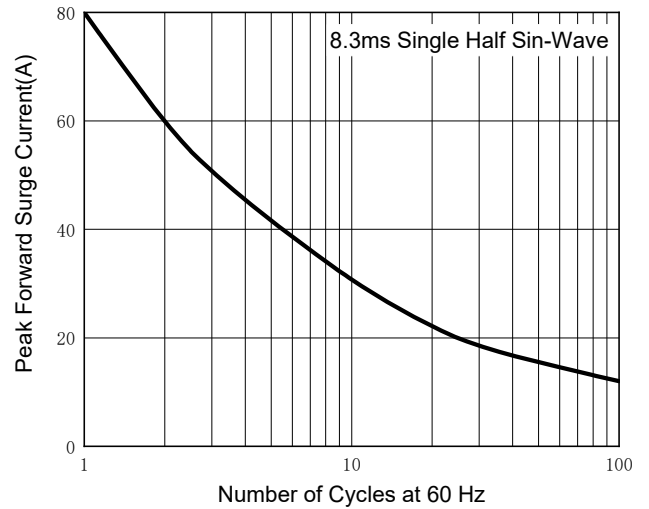

Fig.3:Typical Instantaneous Forward Characteristics

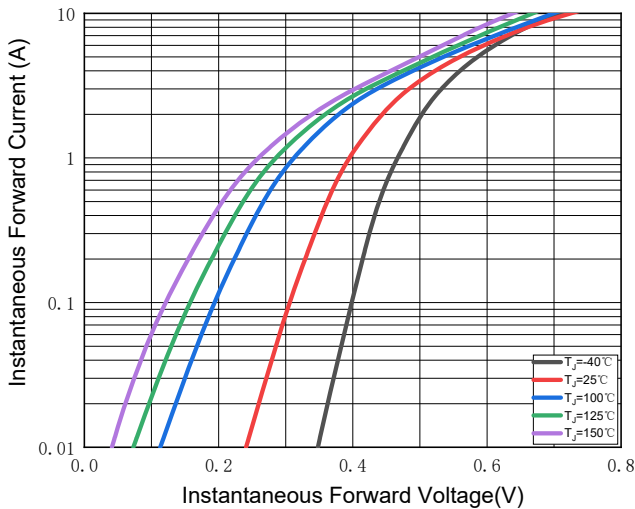
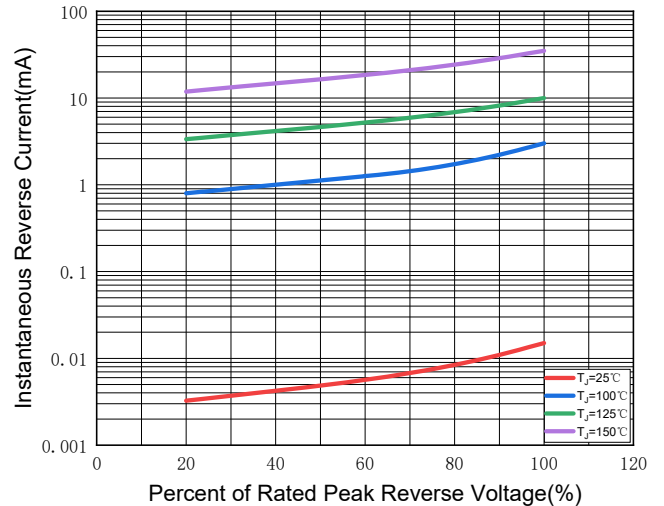

Fig.4:Typical Reverse Leakage Characteristics



■ Ordering Information (Example)

PREFERRED P/N	PACKING CODE	UNIT WEIGHT(g)	MINIMUM PACKAGE(pcs)	OUTER CARTON QUANTITY(pcs)	DELIVERY MODE
S315Q-S320Q	F1	Approximate 0.0169	3000	120000	7" reel



S315Q THRU S320Q

■ Outline Dimensions

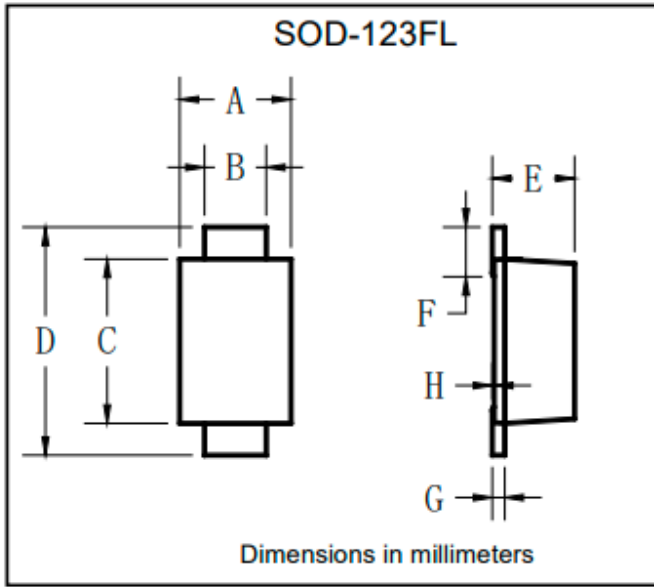

SOD-123FL		
Dim	Min	Max
A	1.60	1.90
B	0.90	1.10
C	2.55	2.85
D	3.60	3.90
E	1.00	1.20
F	0.40	0.90
G	0.10	0.25
H	0.02	0.05

■ Suggested pad layout

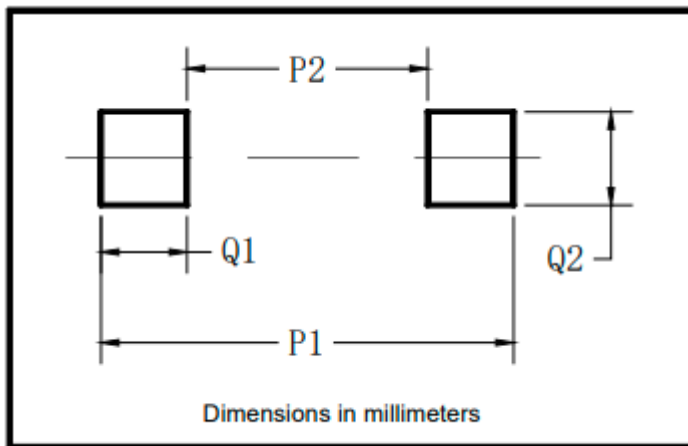

SOD-123FL	
Dim	Millimeters
P1	3.90
P2	1.90
Q1	1.00
Q2	1.50



S315Q THRU S320Q

Disclaimer

The information presented in this document is for reference only. Yangzhou Yangjie Electronic Technology Co., Ltd. reserves the right to make changes without notice for the specification of the products displayed herein to improve reliability, function or design or otherwise.

The product listed herein is designed to be used with automotive electronics, are not designed for use in medical, lifesaving, lifesustaining, or military, Yangjie or anyone on its behalf, assumes no responsibility or liability for any damages resulting from such improper use of sale.

This publication supersedes & replaces all information previously supplied. For additional information, please visit our website [http:// www.21yangjie.com](http://www.21yangjie.com) , or consult your nearest Yangjie's sales office for further assistance.