

FERROXCUBE

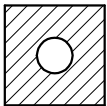

1 2 3 4

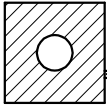
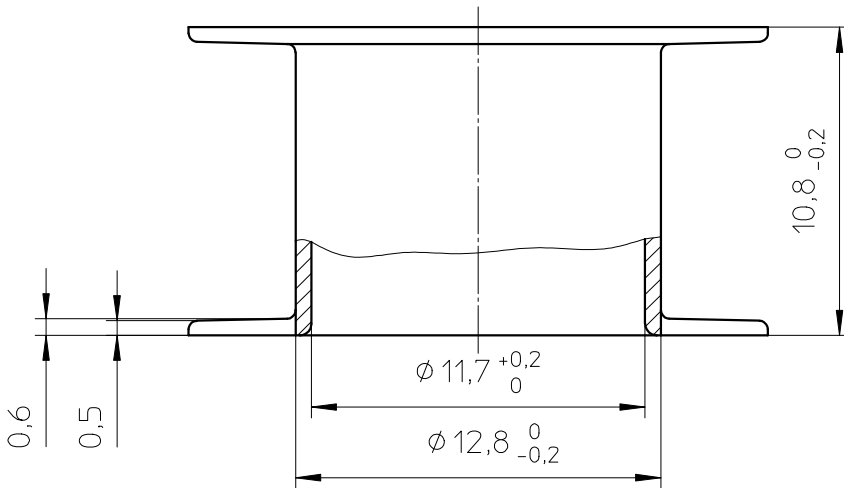
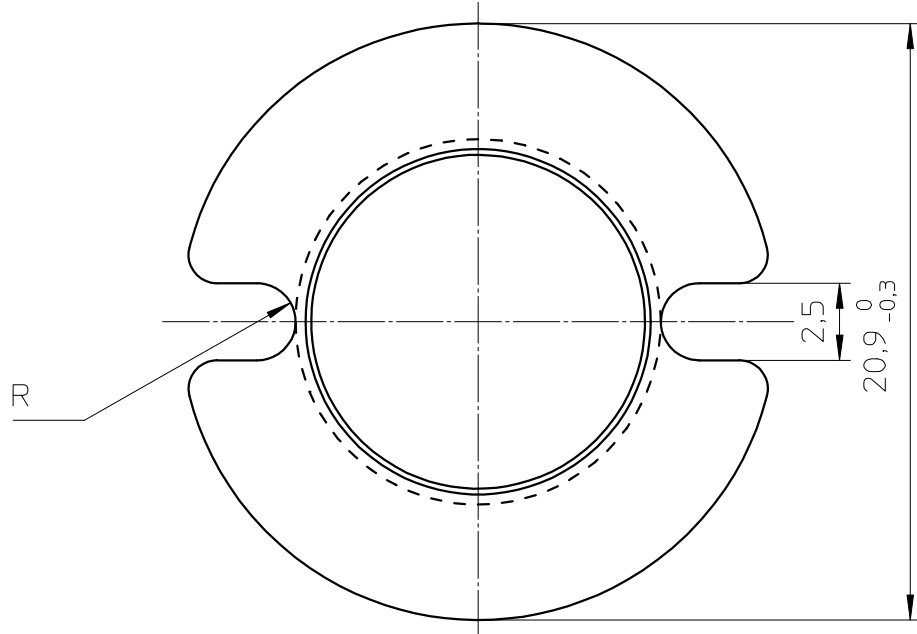

Coil former material: Valox 420SEO (PBT), glass-reinforced.
 UL file number: E45329 - UL94V-0.
 Max. operating temp.: acc. to IEC 60 085 class F, 155°C.
 Min. winding area: 37,1 mm².
 Mean length of turn: 52,6 mm.

CLASS.NO.						97-08-22	
		CP-P26/16-1S		4322 021 02441		00-07-04	
00-07-04							
NAME NAAM	M.Veekens	SUPERS. VERV.	4322 021 30332	1	SH BL	112	- 001 010
MPA	CHECK CONTR.	DAT.	97-08-22	Property of Eigendom van		© FERROXCUBE 2000	
						A4	