

INN030FQ015A

1. General Description

GaN-on-Silicon enhancement mode high-electron-mobility-transistor (HEMT) in FCQFN with 5 mm x 4 mm package size.

2. Features

- GaN-on-Silicon E-mode HEMT technology
- Very low gate charge
- Ultra-low on resistance
- Zero reverse recovery charge

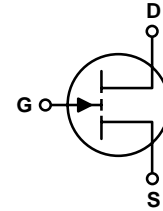

3. Applications

- High frequency DC-DC converter
- Battery charger
- Battery management system
- Notebook
- Industry

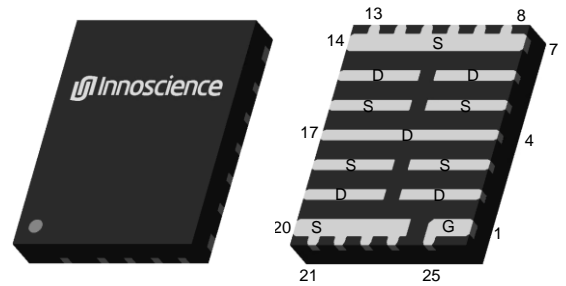

4. Key Performance Parameters

Table 1 Key performance parameters at $T_J = 25\text{ }^\circ\text{C}$

Parameter	Value	Unit
$V_{DS,max}$	30	V
$R_{DS(on),max}$ @ $V_{GS} = 5\text{ V}$	1.5	m Ω
$Q_{G,typ}$ @ $V_{DS} = 15\text{ V}$	22.8	nC
$I_{DS,Pulse}$	300	A
Q_{OSS} @ $V_{DS} = 15\text{ V}$	43	nC

5. Pin Information

Table 2 Pin information

Pin	Pin description	Pin function
1, 25	Gate	Driver Gate
3, 5, 7-14, 16, 18, 20-24	Source	Source
2, 4, 6, 15, 17, 19	Drain	Power Drain

Table 3 Ordering information

Type/Ordering Code	Package	Product Code
INN030FQ015A	FCQFN 5mm x 4mm	C06

Table of Contents

1. General Description	1
2. Features	1
3. Applications	1
4. Key Performance Parameters	1
5. Pin Information	1
6. Maximum Ratings	3
7. Thermal Characteristics	4
8. Electric Characteristics	5
9. Electric Characteristics Diagrams	7
10. Package Outlines	12
11. Reel Information	13
12. Land Pattern	14
13. Revision History	15

6. Maximum Ratings

at $T_J = 25\text{ °C}$ unless otherwise specified.

Continuous application of maximum ratings can deteriorate transistor lifetime. For further information, contact Innoscience sales office.

Table 4 Maximum ratings

SYMBOL	PARAMETER	MAX	UNIT
V_{DS}	Drain-to-Source Voltage (Continuous)	30	V
I_D	Continuous Current	60	A
	Pulsed (25 °C , $T_{Pulse} = 300\ \mu\text{s}$)	300	A
V_{GS}	Gate-to-Source Voltage	6	V
	Gate-to-Source Voltage	-4	V
P_{tot}	Power dissipation ($T_B = 25\text{ °C}$)	85	W
T_J	Operating Temperature	-40 to 150	°C
T_{STG}	Storage Temperature	-40 to 150	°C

7. Thermal Characteristics

Table 5 Thermal characteristics

SYMBOL	PARAMETER	TYP	UNIT	Note/Test Condition
R _{θJC}	Thermal Resistance, Junction to Case	12.4	°C/W	
R _{θJB}	Thermal Resistance, Junction to Board	1.5	°C/W	
R _{θJA}	Thermal Resistance, Junction to Ambient ¹	54.5	°C/W	
T _{sold}	Maximum Reflow Soldering Temperature	260	°C	MSL3

Note 1: R_{θJA} is determined with the device mounted on one square inch of copper pad, single layer 2 oz copper on FR4 board.

8. Electric Characteristics

at $T_J = 25\text{ °C}$, unless specified otherwise

Table 6 Static characteristics

SYMBOL	PARAMETER	MIN	TYP	MAX	UNIT	TEST CONDITIONS
BV_{DSS}	Drain-to-Source Voltage	30	-	-	V	$V_{GS} = 0\text{ V}$, $I_D = 50\text{ }\mu\text{A}$
I_{DSS}	Drain Source Leakage	-	10	100	μA	$V_{GS} = 0\text{ V}$, $V_{DS} = 24\text{ V}$
	Drain Source Leakage (125 °C)	-	100	1000	μA	$V_{GS} = 0\text{ V}$, $V_{DS} = 24\text{ V}$
I_{GSS}	Gate-to-Source Forward Leakage	-	6	60	μA	$V_{GS} = 5\text{ V}$
	Gate-to-Source Forward Leakage (125 °C)	-	60	600	μA	$V_{GS} = 5\text{ V}$
	Gate-to-Source Reverse Leakage	-	30	300	μA	$V_{GS} = -4\text{ V}$
$V_{GS(TH)}$	Gate Threshold Voltage	0.9	-	2.1	V	$V_{DS} = V_{GS}$, $I_D = 5\text{ mA}$
$R_{DS(on)}$	Drain-Source On-state Resistance	-	1.2	1.5	$\text{m}\Omega$	$V_{GS} = 5\text{ V}$, $I_D = 15\text{ A}$
V_{SD}	Source-Drain Forward Voltage	-	1.65	-	V	$I_S = 0.5\text{ A}$, $V_{GS} = 0\text{ V}$

Table 7 Dynamic characteristics

SYMBOL	PARAMETER	MIN	TYP	MAX	UNIT	TEST CONDITIONS
C _{ISS}	Input Capacitance	-	3.4	-	nF	V _{GS} = 0 V, V _{DS} = 15 V
C _{OSS}	Output Capacitance	-	1.8	-		V _{GS} = 0 V, V _{DS} = 15 V
C _{RSS}	Reverse Transfer Capacitance	-	0.1	-		V _{GS} = 0 V, V _{DS} = 15 V
C _{OSS(ER)}	Energy Related C _{OSS}	-	2.5	-		V _{GS} = 0 V, V _{DS} = 0 V to 15 V
C _{OSS(TR)}	Time Related C _{OSS}	-	2.8	-		V _{GS} = 0 V, V _{DS} = 0 V to 15 V
R _G	Gate resistance	-	1.6	-	Ω	f = 1 MHz
Q _G	Total Gate Charge	-	22.8	-	nC	V _{GS} = 5 V, V _{DS} = 15 V, I _D = 15 A
Q _{GS}	Gate to Source Charge	-	5.5	-		V _{DS} = 15 V, I _D = 15 A
Q _{GD}	Gate to Drain Charge	-	3.2	-		V _{DS} = 15 V, I _D = 15 A
Q _{G(TH)}	Gate Charge at Threshold	-	3.8	-		V _{DS} = 15 V, I _D = 15 A
Q _{OSS}	Output Charge	-	43	-		V _{GS} = 0 V, V _{DS} = 15 V

9. Electric Characteristics Diagrams

at $T_J = 25^\circ\text{C}$, unless specified otherwise

Figure 1 Typical Output Characteristics ($T_J = 25^\circ\text{C}$)

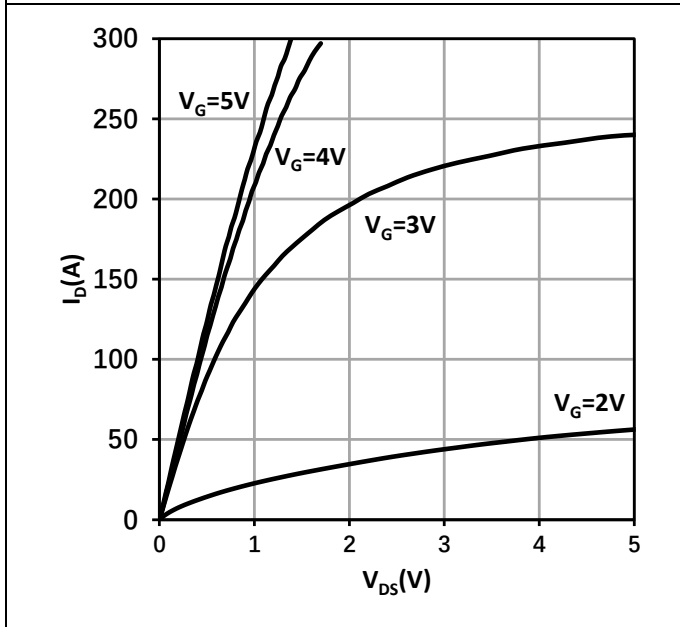

Figure 2 Typical Output Characteristics ($T_J = 125^\circ\text{C}$)

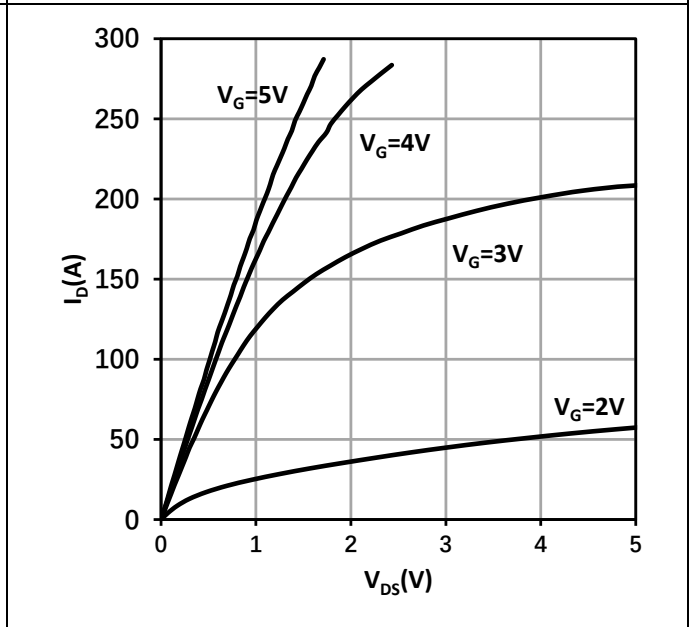

Figure 3 Typical On-state Resistance ($T_J = 25^\circ\text{C}$)

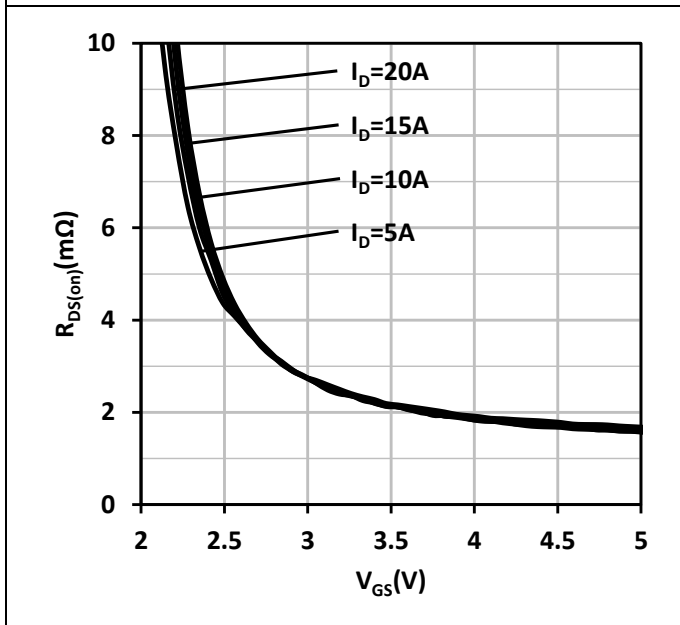

Figure 4 Typical On-state Resistance ($T_J = 125^\circ\text{C}$)

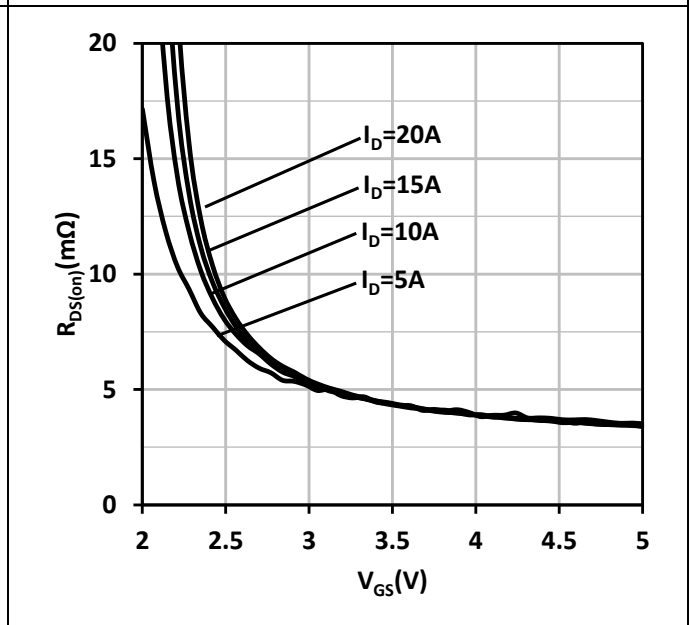

Figure 5 Normalized On-State Resistance vs. Temp.

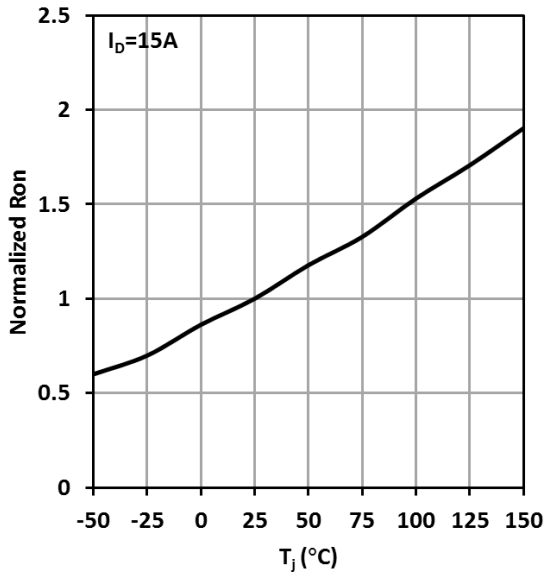

Figure 6 Typical Transfer Characteristics

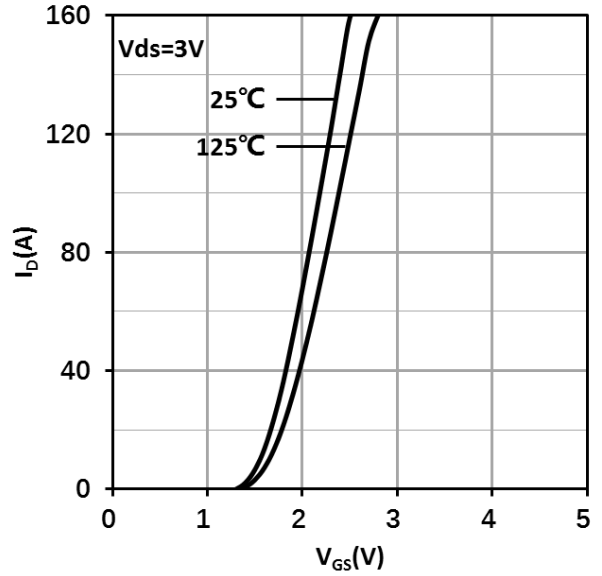

Figure 7 Typical Reverse Characteristics ($V_{GS} \leq 0, T_J = 25^\circ C$)

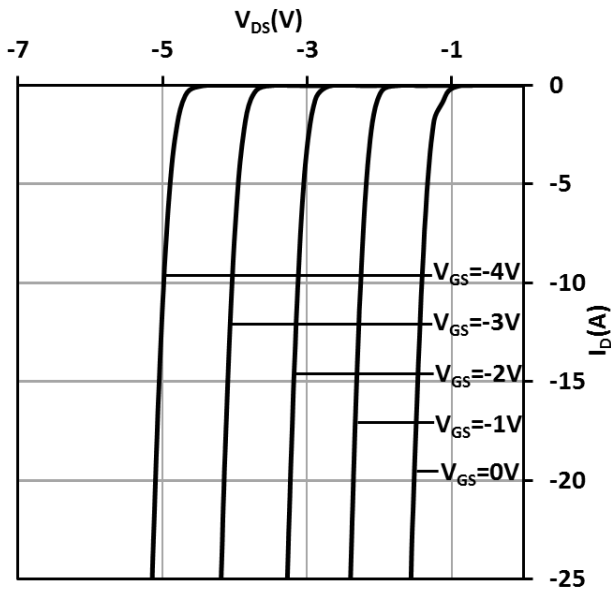

Figure 8 Typical Reverse Characteristics ($V_{GS} \geq 0, T_J = 25^\circ C$)

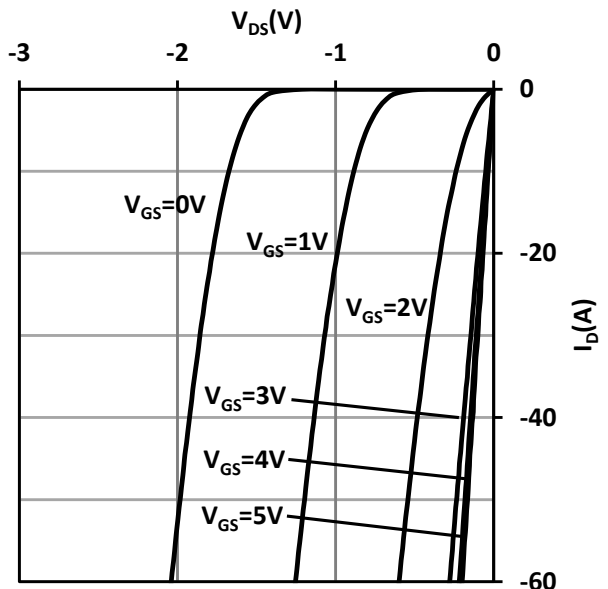

Figure 9 Typical Reverse Characteristics
($V_{GS} \leq 0, T_J = 125^\circ\text{C}$)

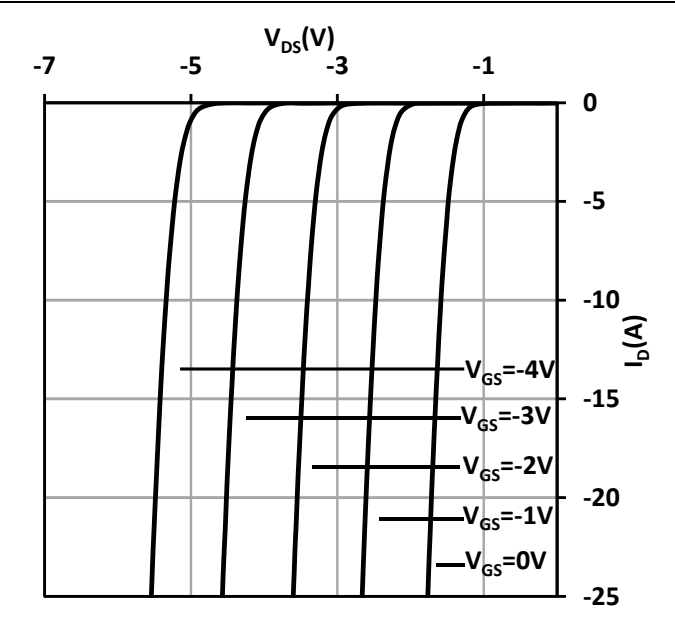

Figure 10 Typical Reverse Characteristics
($V_{GS} \geq 0, T_J = 125^\circ\text{C}$)

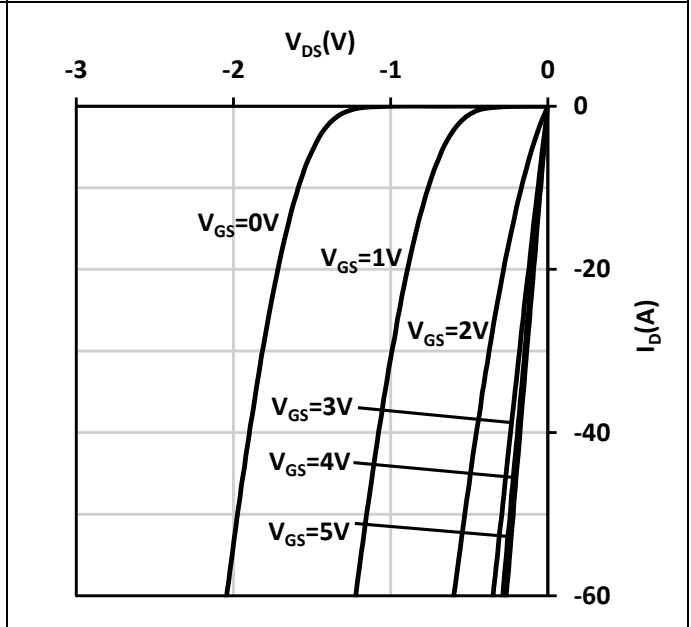

Figure 11 Typical Capacitances Characteristics

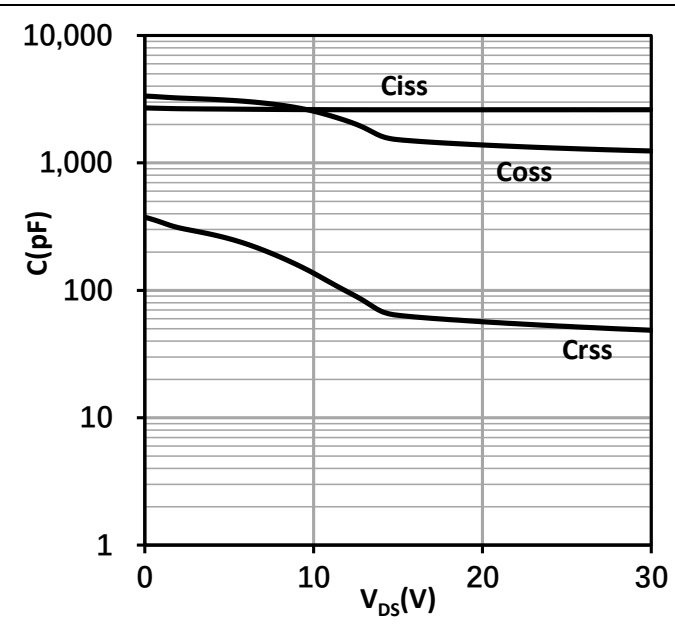

Figure 12 Typical Gate Charge

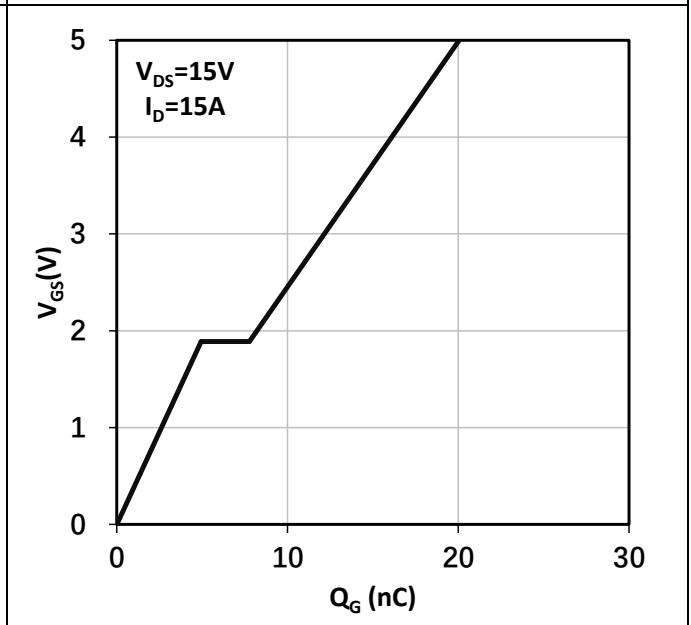

Figure 13 Normalized Threshold Voltage vs. Temp.

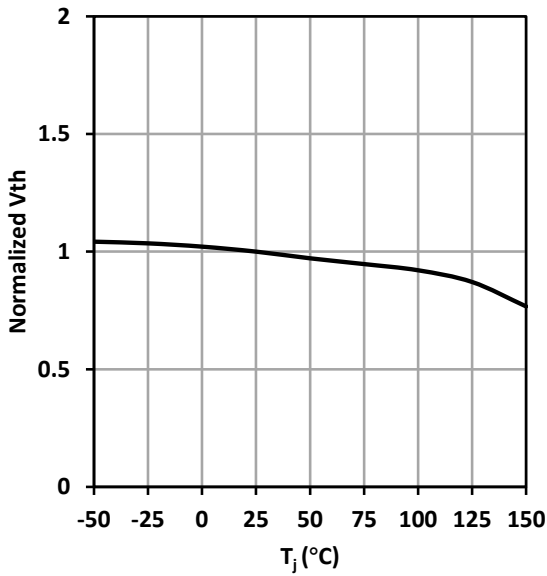

Figure 14 Output Charge

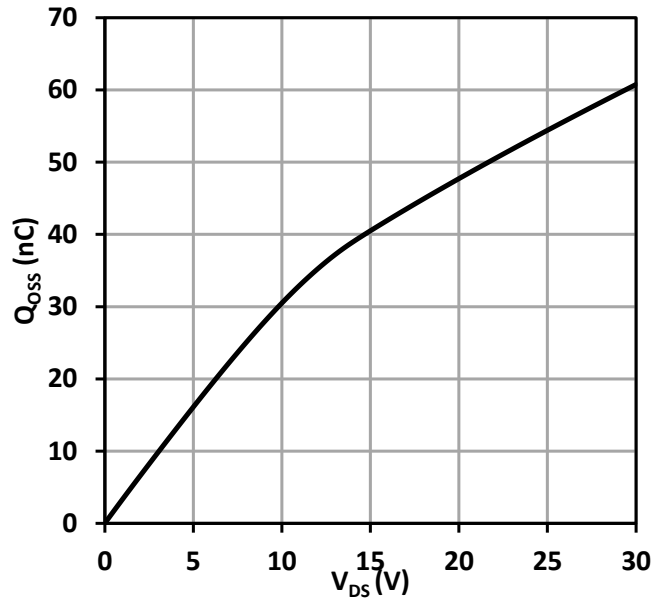

Figure 15 Output Capacitance Stored Energy

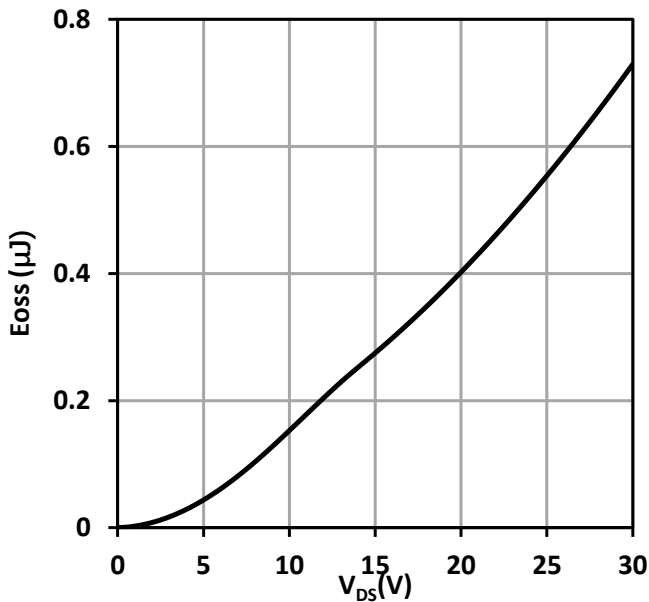

Figure 16 Power Dissipation

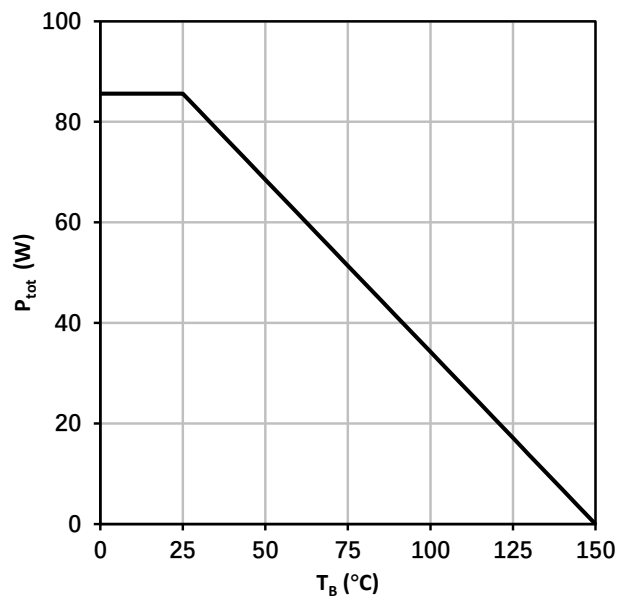

Figure 17 Safe Operating Area

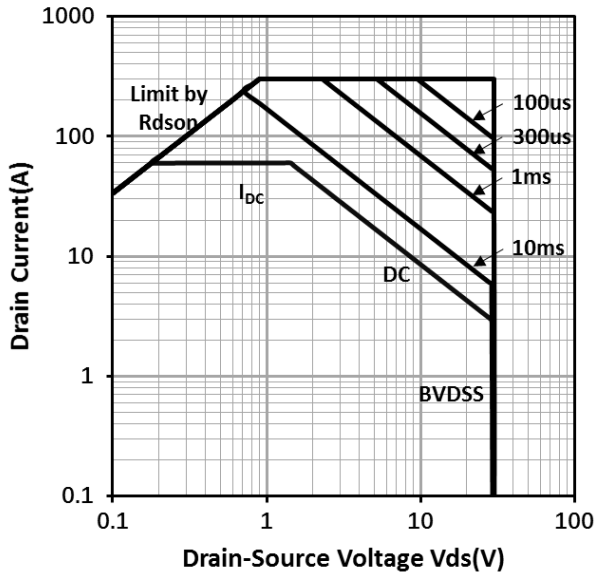
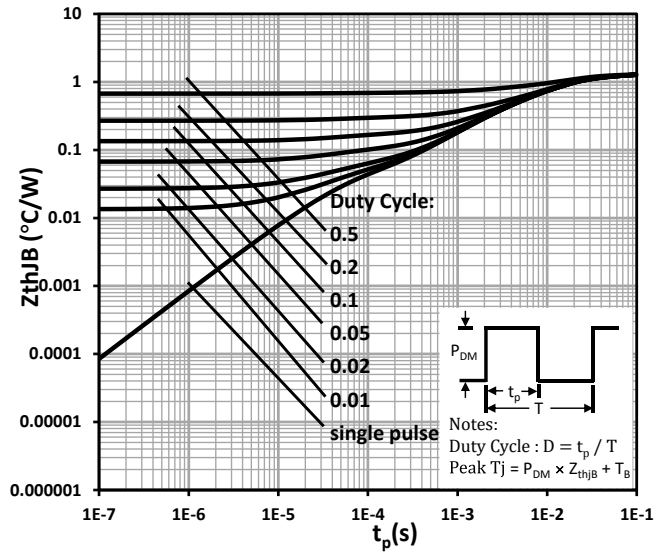
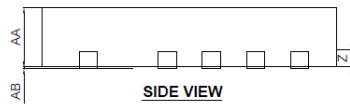
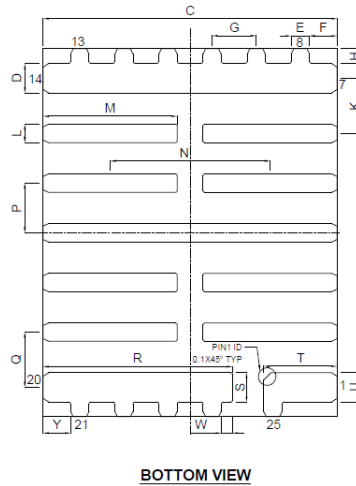
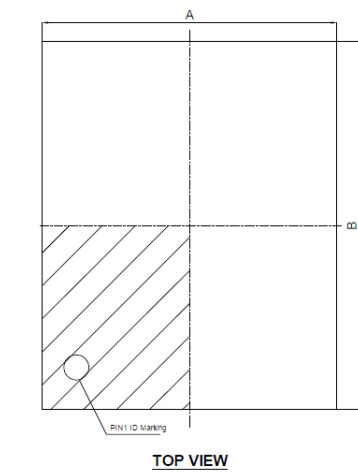

Figure 18 Max. Transient Thermal Impedance



10. Package Outlines

Package Reference



NOTE:
 1) ALL DIMENSION ARE IN MILLIMETERS.
 2) BOTTOM VIEW IS FT TESTER SIDE VIEW.
 3) LEAD COPLANARITY SHALL BE 0.08 MILLIMETERS MAX.
 4) COMPLIES WITH JEDEC MO-220.
 5) DRAWING IS NOT TO SCALE.

SYMBOL	MILLIMETER			NOTE
	MIN	NOM	MAX	
A	3.9	4.0	4.1	
B	4.9	5.0	5.1	
C	3.9	4.0	4.1	
D	0.350	0.400	0.450	
E	0.200	0.250	0.300	11X
F		0.375	REF	2X
G		0.600	BASIC	8X
H		0.200	REF	11X
K		0.750	BASIC	2X
L	0.200	0.250	0.300	10X
M	1.725	1.825	1.925	8X
N		2.175	BASIC	4X
P		0.675	BASIC	8X
Q		0.750	BASIC	2X
R	2.477	2.577	2.677	
S	0.350	0.400	0.450	
T	0.899	0.999	1.099	
U	0.350	0.400	0.450	
W		0.152	REF	
Y		0.375	BASIC	
Z		0.203	REF	
AA	0.650	0.750	0.850	
AB	0	0.02	0.05	

Marking Reference

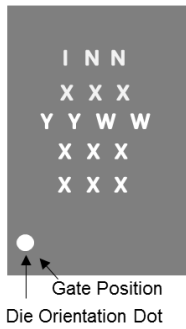

Row	Description	Example
Row 1	Company name	INN
Row 2	Product code	XXX
Row 3	Date code	YYWW
Row 4	Lot Code	XXX
Row 5		XXX

11. Reel Information

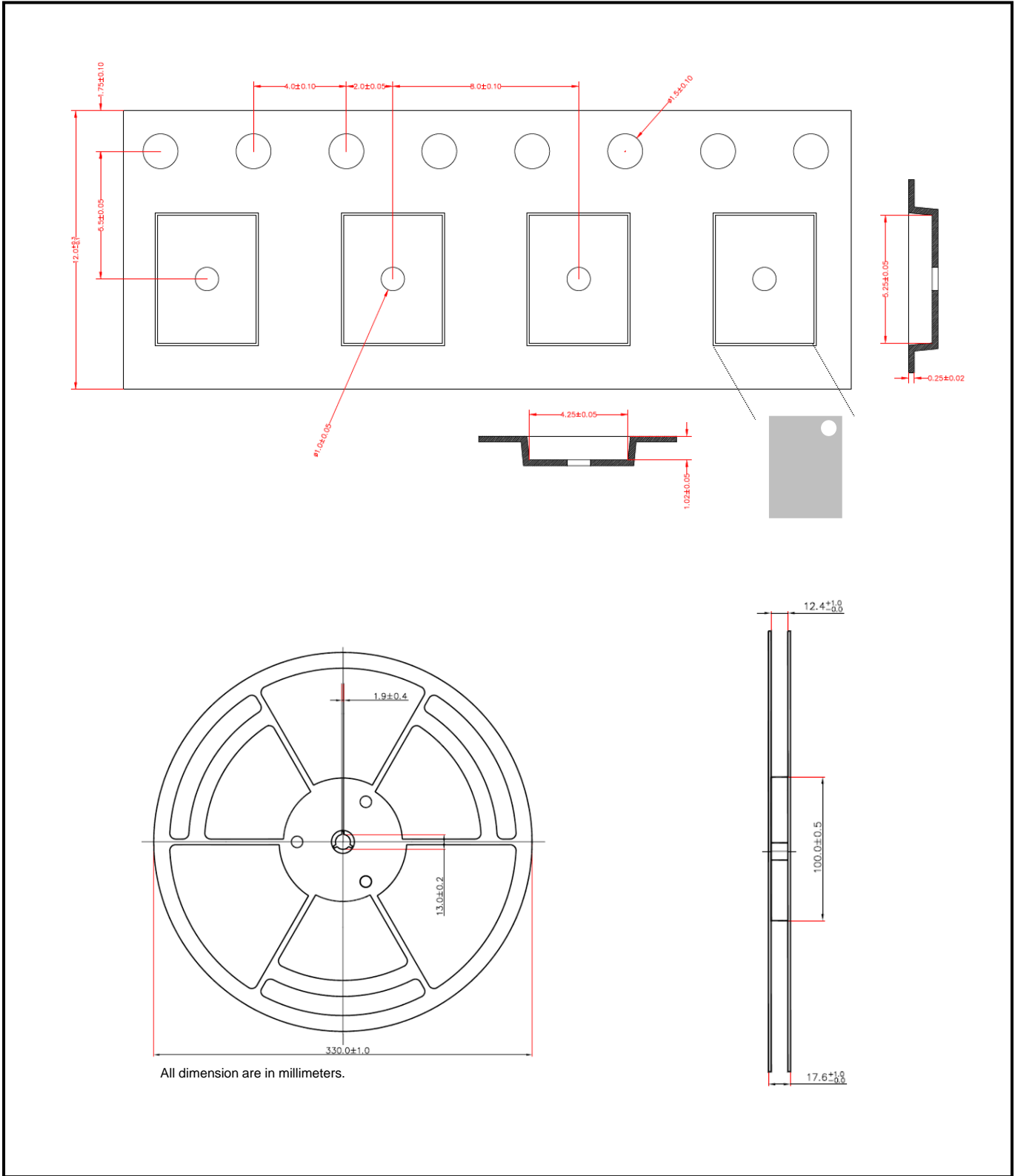

12. Land Pattern

Recommended Land Pattern

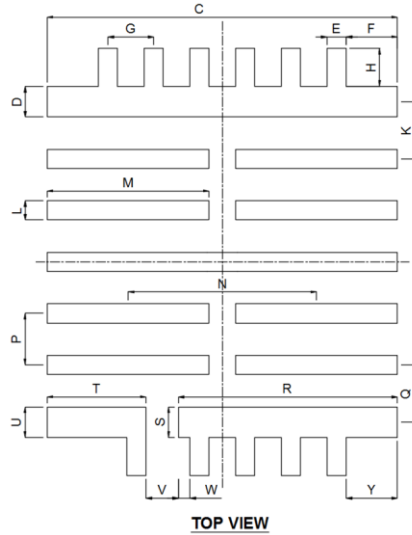

SYMBOL	MILLIMETER NOM	NOTE
C	4.600	
D	0.400	
E	0.250	11X
F	0.675	2X
G	0.600	8X
H	0.500	11X
K	0.750	2X
L	0.250	10X
M	2.125	8X
N	2.475	4X
P	0.675	8X
Q	0.750	2X
R	2.875	
S	0.400	
T	1.299	
U	0.400	
V	0.425	
W	0.152	
Y	0.675	

NOTE:

- 1) LAND PATTERN IS SOLDER MASK DEFINED.
- 2) IT IS RECOMMENDED TO HAVE ON-CU TRACE PCB VIAS.

Recommended Stencil Drawing

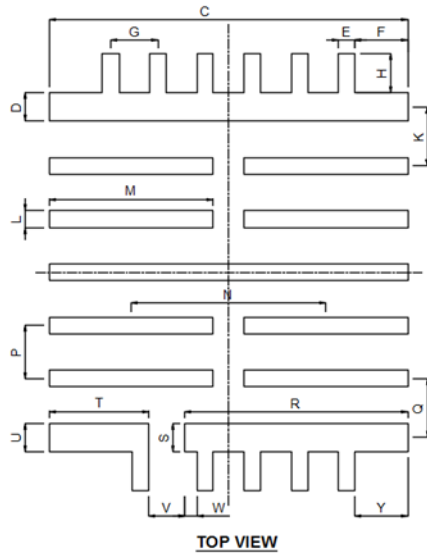

SYMBOL	MILLIMETER NOM	NOTE
C	4.560	
D	0.360	
E	0.210	11X
F	0.675	2X
G	0.600	8X
H	0.500	11X
K	0.750	2X
L	0.210	10X
M	2.085	8X
N	2.475	4X
P	0.675	8X
Q	0.750	2X
R	2.835	
S	0.360	
T	1.259	
U	0.360	
V	0.465	
W	0.152	
Y	0.675	

13. Revision History

Major changes since the last revision

Revision	Date	Description of changes
1.0	2023-12-27	1.0 Version Setup

Important Notice

The information provided in this document is intended as a guide only and shall not in any event be regarded as a guarantee of conditions, characteristics or performance. Innoscience does not assume any liability arising out of the application or use of any product described herein, including but not limited to any personal injury, death, or property or environmental damage. No licenses, patent rights, or any other intellectual property rights is granted or conveyed. Innoscience reserves the right to modify without notice. All rights reserved.