



VHF Chokes

Series/Type: B82134

The following products presented in this data sheet are being withdrawn.

Ordering Code	Substitute Product	Date of Withdrawal	Deadline Last Orders	Last Shipments
B82132A5602M000		2007-09-21	2007-12-31	2008-03-31
B82134A5402M000		2007-09-21	2007-12-31	2008-03-31
B82133A5602M000		2007-09-21	2007-12-31	2008-03-31

For further information please contact your nearest EPCOS sales office, which will also support you in selecting a suitable substitute. The addresses of our worldwide sales network are presented at www.epcos.com/sales.

Carbonyl iron core

Rated voltage 500 VAC/DC
Rated current 0.15 to 6 A
Rated inductance 1 to 420 μ H

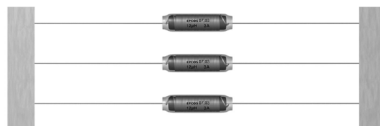
Construction

- Cylinder core of carbonyl iron
- Winding: single-layer, enamel copper wire
- Polyester insulating sleeve

Features

- High resonant frequency
- RoHS-compatible¹⁾

Applications

- RF blocking and filtering
- Interference suppression in small appliances
- Decoupling in telecommunications and entertainment electronics

Marking

L_R and I_R in clear text

Delivery mode

Taped and reeled (for packing and packing units see page 6).

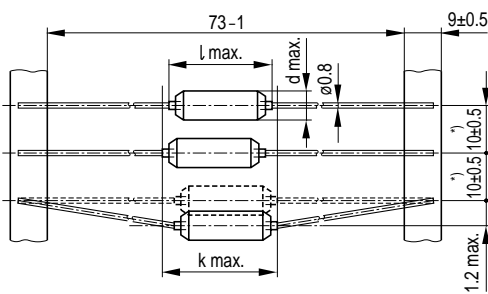
Dimensional drawing

¹⁾ Tolerance over 10 spacings ± 2 mm

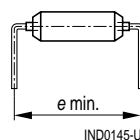

IND0144-Z-E



Lead spacing e_{\min} (mm)	Type
17.5	B82131
22.5	B82132
27.5	B82133
32.5	B82134

1) RoHS-compatible is defined as compatible with the following documents:
 DIRECTIVE 2002/95/EC OF THE EUROPEAN PARLIAMENT AND OF THE COUNCIL of 13 February 2003 on the restriction of the use of certain hazardous substances in electrical and electronic equipment COM (2004) 606 final Proposal for a COUNCIL DECISION amending Directive 2002/95/EC of the European Parliament and of the Council for the purposes of establishing the maximum concentration values for certain hazardous substances in electrical and electronic equipment.

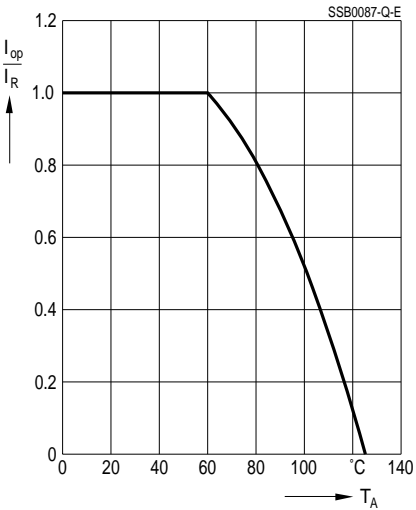
General technical data

Test voltage V_{test}	2500 VAC, 1 min
Rated inductance L_R	Measuring frequency: $L \leq 10 \mu\text{H} = 1 \text{ MHz}$ $10 \mu\text{H} < L \leq 1000 \mu\text{H} = 100 \text{ kHz}$
Inductance tolerance	$\pm 20\%$
Rated current I_R	Referred to 60 °C ambient temperature, for derating see below
Inductance decrease $\Delta L/L_0$	$\leq 10\%$ (referred to initial value) at DC load I_R at 20 °C
DC resistance R_{typ}	Typical value, measured at 20 °C ambient temperature
Resonance frequency $f_{\text{res, min}}$	Typical value, measured with Scalar Network Analyzer ZAS from Rohde & Schwarz
Climatic category (IEC 60068-1)	55/125/56 (-55 °C/+125 °C/56 days damp heat test)
Current derating I_{op}/I_R versus ambient temperature T_A (rated temperature $T_R = 60 \text{ °C}$)	 <p>The graph shows the current derating factor I_{op}/I_R on the y-axis (ranging from 0 to 1.2) against the ambient temperature T_A in °C on the x-axis (ranging from 0 to 140). The curve is constant at 1.0 for temperatures up to 60 °C. Beyond 60 °C, the derating factor decreases, reaching 0 at 125 °C. The graph is identified as SSB0087-Q-E.</p>
 Mounting information	When bending the leads, take care that the bending point is at least 3 mm apart from the face ends of the core and that the start-of-winding-areas are not subjected to any mechanical stress.

Characteristics and ordering codes

I_R A	L_R μ H	R_{typ} Ω	f_{res} MHz	Dimensions (mm)				Approx. weight g	Ordering code
				d_{max}	l_{max}	k_{max}	e_{min}		
0.15	80	11	22	5	14	15.4	17.5	0.8	B82131A5151M000
	160	17	20	5.5	19	20.4	22.5	0.9	B82132A5151M000
	350	21	11	7.5	24	25.4	27.5	2.3	B82133A5151M000
	420	19	12	7.5	29	30.4	32.5	2.6	B82134A5151M000
0.3	40	4.1	31	5	14	15.4	17.5	0.8	B82131A5301M000
	70	5.7	29	5.5	19	20.4	22.5	0.9	B82132A5301M000
	160	6.5	16	7.5	24	25.4	27.5	2.2	B82133A5301M000
	210	6.4	18	7.5	29	30.4	32.5	2.8	B82134A5301M000
0.4	27	2.0	40	5	14	15.4	17.5	0.8	B82131A5401M000
	50	3.0	37	5.5	19	20.4	22.5	1.0	B82132A5401M000
	130	4.8	18	7.5	24	25.4	27.5	2.8	B82133A5401M000
	150	3.5	18	7.5	29	30.4	32.5	2.8	B82134A5401M000
0.7	14	0.76	53	5	14	15.4	17.5	0.8	B82131A5701M000
	23	0.73	55	5.5	19	20.4	22.5	1.0	B82132A5701M000
	55	1.20	26	7.5	24	25.4	27.5	2.4	B82133A5701M000
	60	0.77	34	7.5	29	30.4	32.5	3.0	B82134A5701M000
1.5	6	0.19	84	5	14	15.4	17.5	0.8	B82131A5152M000
	8	0.16	90	5.5	19	20.4	22.5	1.1	B82132A5152M000
	25	0.32	40	7.5	24	25.4	27.5	2.5	B82133A5152M000
	30	0.30	44	7.5	29	30.4	32.5	3.2	B82134A5152M000
2	3	0.09	113	5	14	15.4	17.5	0.8	B82131A5202M000
	6	0.11	108	5.5	19	20.4	22.5	1.1	B82132A5202M000
	14	0.13	57	7.5	24	25.4	27.5	2.8	B82133A5202M000
	20	0.15	59	7.5	29	30.4	32.5	3.3	B82134A5202M000
3	2	0.038	147	5	14	15.4	17.5	1.0	B82131A5302M000
	3	0.035	151	5.5	19	20.4	22.5	1.2	B82132A5302M000
	10	0.077	69	7.5	24	25.4	27.5	2.9	B82133A5302M000
	12	0.090	75	7.5	29	30.4	32.5	3.5	B82134A5302M000
4	1	0.014	199	5	14	15.4	17.5	1.1	B82131A5402M000
	2	0.020	186	5.5	19	20.4	22.5	1.4	B82132A5402M000
	5	0.034	87	7.5	24	25.4	27.5	3.0	B82133A5402M000
	7	0.033	94	7.5	29	30.4	32.5	4.3	B82134A5402M000
6	1	0.010	243	5.5	19	20.4	22.5	1.4	B82132A5602M000
	3	0.019	108	7.5	24	25.4	27.5	3.2	B82133A5602M000

Impedance $|Z|$ versus frequency f

measured as per VDE 0565-2

(typical values)

B82131A5***M000

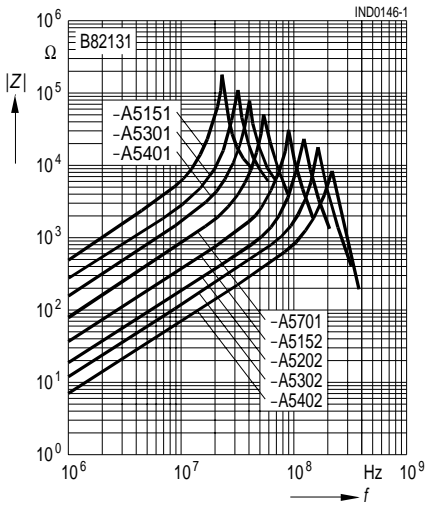

B82132A5***M000

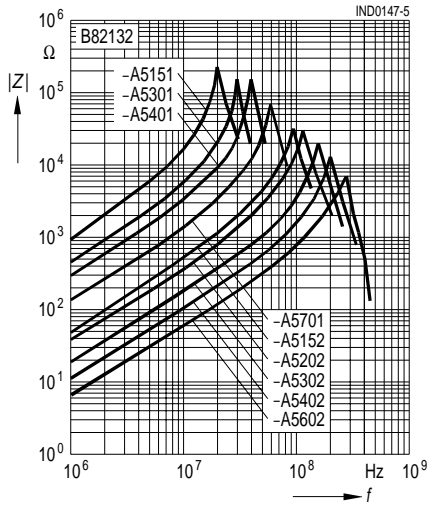

B82133A5***M000

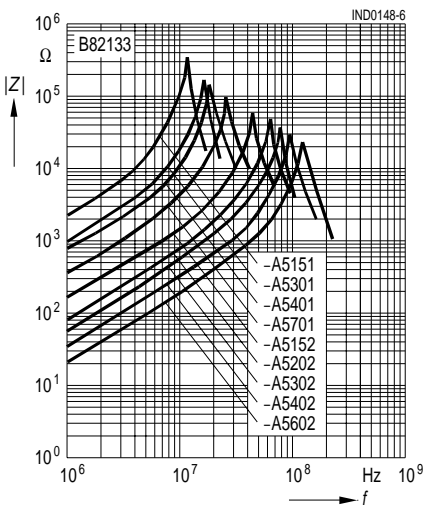

B82134A5***M000

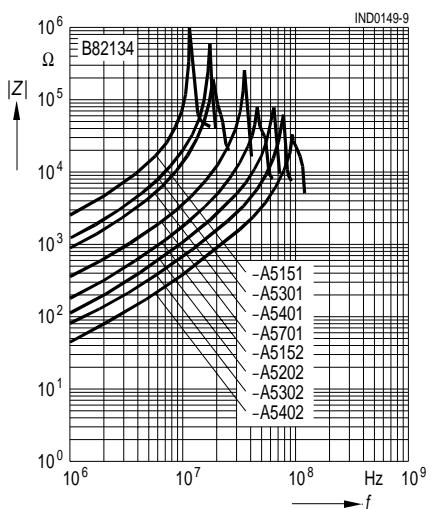

Packing

Reel packing for B82131 ... B82134

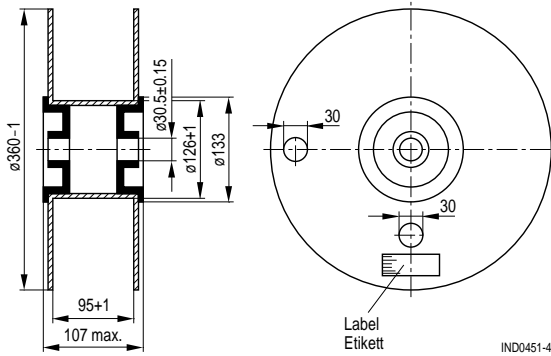
Packing units

Type	Pieces/reel
B82131	2000
B82132	2000
B82133	1000
B82134	1000

Important notes

The following applies to all products named in this publication:

1. Some parts of this publication contain **statements about the suitability of our products for certain areas of application**. These statements are based on our knowledge of typical requirements that are often placed on our products in the areas of application concerned. We nevertheless expressly point out **that such statements cannot be regarded as binding statements about the suitability of our products for a particular customer application**.

As a rule, EPCOS is either unfamiliar with individual customer applications or less familiar with them than the customers themselves. For these reasons, it is always ultimately incumbent on the customer to check and decide whether an EPCOS product with the properties described in the product specification is suitable for use in a particular customer application.

2. We also point out that in **individual cases, a malfunction of passive electronic components or failure before the end of their usual service life cannot be completely ruled out in the current state of the art, even if they are operated as specified**. In customer applications requiring a very high level of operational safety and especially in customer applications in which the malfunction or failure of a passive electronic component could endanger human life or health (e.g. in accident prevention or life-saving systems), it must therefore be ensured by means of suitable design of the customer application or other action taken by the customer (e.g. installation of protective circuitry or redundancy) that no injury or damage is sustained by third parties in the event of malfunction or failure of a passive electronic component.

3. **The warnings, cautions and product-specific notes must be observed.**

4. In order to satisfy certain technical requirements, **some of the products described in this publication may contain substances subject to restrictions in certain jurisdictions (e.g. because they are classed as “hazardous”)**. Useful information on this will be found in our Material Data Sheets on the Internet (www.epcos.com/material). Should you have any more detailed questions, please contact our sales offices.

5. We constantly strive to improve our products. Consequently, **the products described in this publication may change from time to time**. The same is true of the corresponding product specifications. Please check therefore to what extent product descriptions and specifications contained in this publication are still applicable before or when you place an order.

We also **reserve the right to discontinue production and delivery of products**. Consequently, we cannot guarantee that all products named in this publication will always be available.

6. Unless otherwise agreed in individual contracts, **all orders are subject to the current version of the “General Terms of Delivery for Products and Services in the Electrical Industry” published by the German Electrical and Electronics Industry Association (ZVEI)**.

7. The trade names EPCOS, CeraDiode, CSSP, PhaseCap, PhaseMod, SilverCap, SIFI, SIMID, SIKOREL, SIOV, SIP5D, SIP5K, TOPcap, UltraCap, WindCap are **trademarks registered or pending** in Europe and in other countries. Further information will be found on the Internet at www.epcos.com/trademarks.