

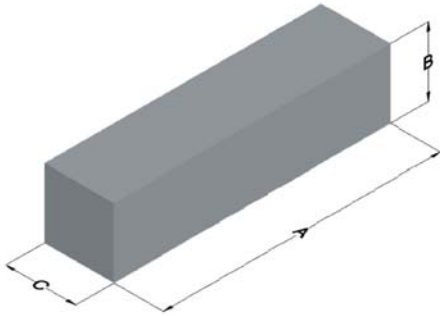

00X5528B026

110 Delta Drive
 Pittsburgh, PA 15238
 NAFTA Sales: (1)800-245-3984
 HK Sales : (852)3102-9337
 magnetics@spang.com
 www.mag-inc.com



XFLUX Permeability (μ)	Core Marking	
	Lot Number	Part number
26	XXXXXX	X5528B026

	Dimensions		Tolerance (\pm)		Packaging
	(mm)	(in)	(mm)	(in)	
A	54.86	2.160	0.64	0.025	Cardboard cut-outs Box Qty= 64 pcs
B	27.56	1.085	0.41	0.016	
C	20.6	0.812	0.39	0.015	

Physical Characteristics		Temperature Rating	Note:
Volume V_e (mm ³)	Weight (g)	Curie Temp: 700°C	Cosmetic Standard: Magnetix' Xflux shapes criteria for appearance.
31,200	180		

