

DOSEMI

IGBT

DG15X06T1

600V/15A IGBT with Diode

General Description

DOSEMI IGBT Power Discrete provides ultra low conduction loss as well as low switching loss. They are designed for the applications such as general inverters and UPS.

Features

- Low $V_{CE(sat)}$ Fast IGBT technology
- Low switching loss
- Maximum junction temperature 175°C
- $V_{CE(sat)}$ with positive temperature coefficient
- Fast & soft reverse recovery anti-parallel FWD
- Lead free package

Typical Applications

- Inverter for motor drive
- AC and DC servo drive amplifier
- Uninterruptible power supply

Equivalent Circuit Schematic

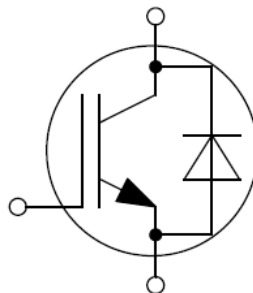

Absolute Maximum Ratings $T_C=25^{\circ}\text{C}$ unless otherwise noted**IGBT**

Symbol	Description	Value	Unit
V_{CES}	Collector-Emitter Voltage	600	V
V_{GES}	Gate-Emitter Voltage	+20	V
I_C	Collector Current @ $T_C=25^{\circ}\text{C}$	27	A
	@ $T_C=100^{\circ}\text{C}$	24	
I_{CM}	Pulsed Collector Current t_p limited by T_{jmax}	45	A
P_D	Maximum Power Dissipation @ $T_j=175^{\circ}\text{C}$	235	W

Diode

Symbol	Description	Value	Unit
V_{RRM}	Repetitive Peak Reverse Voltage	600	V
I_F	Diode Continuous Forward Current	27	A
I_{FM}	Diode Maximum Forward Current t_p limited by T_{jmax}	45	A

Discrete

Symbol	Description	Values	Unit
T_{jop}	Operating Junction Temperature	-40 to +175	$^{\circ}\text{C}$
T_{STG}	Storage Temperature Range	-55 to +150	$^{\circ}\text{C}$
T_S	Soldering Temperature, 1.6mm from case for 10s	260	$^{\circ}\text{C}$
M	Mounting Torque, Screw M3	0.6	N.m

IGBT Characteristics $T_C=25^\circ\text{C}$ unless otherwise noted

Symbol	Parameter	Test Conditions	Min.	Typ.	Max.	Unit	
$V_{CE(sat)}$	Collector to Emitter Saturation Voltage	$I_C=15\text{A}, V_{GE}=15\text{V}, T_j=25^\circ\text{C}$		1.45	1.90	V	
		$I_C=15\text{A}, V_{GE}=15\text{V}, T_j=125^\circ\text{C}$		1.60			
		$I_C=15\text{A}, V_{GE}=15\text{V}, T_j=150^\circ\text{C}$		1.70			
$V_{GE(th)}$	Gate-Emitter Threshold Voltage	$I_C=2.40\text{mA}, V_{CE}=V_{GE}, T_j=25^\circ\text{C}$	5.2	5.8	6.5	V	
I_{CES}	Collector Cut-Off Current	$V_{CE}=V_{CES}, V_{GE}=0\text{V}, T_j=25^\circ\text{C}$			1.0	mA	
I_{GES}	Gate-Emitter Leakage Current	$V_{GE}=V_{GES}, V_{CE}=0\text{V}, T_j=25^\circ\text{C}$			400	nA	
R_{Gint}	Internal Gate Resistance			0		Ω	
C_{ies}	Input Capacitance	$V_{CE}=25\text{V}, f=1\text{MHz}, V_{GE}=0\text{V}$		1.74		nF	
C_{res}	Reverse Transfer Capacitance			0.03		nF	
Q_G	Gate Charge	$V_{GE}=-15\dots+15\text{V}$		0.10		μC	
$t_{d(on)}$	Turn-On Delay Time	$V_{CC}=300\text{V}, I_C=15\text{A}, R_G=22\Omega, V_{GE}=\pm 15\text{V}, T_j=25^\circ\text{C}$		11		ns	
t_r	Rise Time			9		ns	
$t_{d(off)}$	Turn-Off Delay Time			88		ns	
t_f	Fall Time			68		ns	
E_{on}	Turn-On Switching Loss			0.20		mJ	
E_{off}	Turn-Off Switching Loss			0.27		mJ	
$t_{d(on)}$	Turn-On Delay Time		$V_{CC}=300\text{V}, I_C=15\text{A}, R_G=22\Omega, V_{GE}=\pm 15\text{V}, T_j=125^\circ\text{C}$		11		ns
t_r	Rise Time				12		ns
$t_{d(off)}$	Turn-Off Delay Time			104		ns	
t_f	Fall Time			88		ns	
E_{on}	Turn-On Switching Loss			0.26		mJ	
E_{off}	Turn-Off Switching Loss			0.35		mJ	
$t_{d(on)}$	Turn-On Delay Time	$V_{CC}=300\text{V}, I_C=15\text{A}, R_G=22\Omega, V_{GE}=\pm 15\text{V}, T_j=150^\circ\text{C}$			11		ns
t_r	Rise Time				12		ns
$t_{d(off)}$	Turn-Off Delay Time			112		ns	
t_f	Fall Time			96		ns	
E_{on}	Turn-On Switching Loss			0.29		mJ	
E_{off}	Turn-Off Switching Loss			0.37		mJ	
I_{SC}	SC Data		$t_p \leq 6\mu\text{s}, V_{GE}=15\text{V}, T_j=150^\circ\text{C}, V_{CC}=360\text{V}, V_{CEM} \leq 600\text{V}$		75		A

Diode Characteristics $T_C=25^\circ\text{C}$ unless otherwise noted

Symbol	Parameter	Test Conditions	Min.	Typ.	Max.	Unit
V_F	Diode Forward Voltage	$I_F=15\text{A}, V_{GE}=0\text{V}, T_j=25^\circ\text{C}$		1.60	2.05	V
		$I_F=15\text{A}, V_{GE}=0\text{V}, T_j=125^\circ\text{C}$		1.55		
		$I_F=15\text{A}, V_{GE}=0\text{V}, T_j=150^\circ\text{C}$		1.50		
Q_r	Recovered Charge	$V_R=300\text{V}, I_F=15\text{A},$ $-di/dt=1800\text{A}/\mu\text{s}, V_{GE}=-15\text{V}$ $T_j=25^\circ\text{C}$		0.88		μC
I_{RM}	Peak Reverse Recovery Current			25.3		A
E_{rec}	Reverse Recovery Energy			0.18		mJ
Q_r	Recovered Charge	$V_R=300\text{V}, I_F=15\text{A},$ $-di/dt=1800\text{A}/\mu\text{s}, V_{GE}=-15\text{V}$ $T_j=125^\circ\text{C}$		1.54		μC
I_{RM}	Peak Reverse Recovery Current			27.5		A
E_{rec}	Reverse Recovery Energy			0.31		mJ
Q_r	Recovered Charge	$V_R=300\text{V}, I_F=15\text{A},$ $-di/dt=100\text{A}/\mu\text{s}, V_{GE}=-15\text{V}$ $T_j=150^\circ\text{C}$		1.87		μC
I_{RM}	Peak Reverse Recovery Current			28.6		A
E_{rec}	Reverse Recovery Energy			0.41		mJ

Discrete Characteristics $T_C=25^\circ\text{C}$ unless otherwise noted

Symbol	Parameter	Min.	Typ.	Max.	Unit
R_{thJC}	Junction-to-Case (per IGBT)			0.638	K/W
	Junction-to-Case (per Diode)			1.030	
R_{thJA}	Junction-to-Ambient		62		K/W

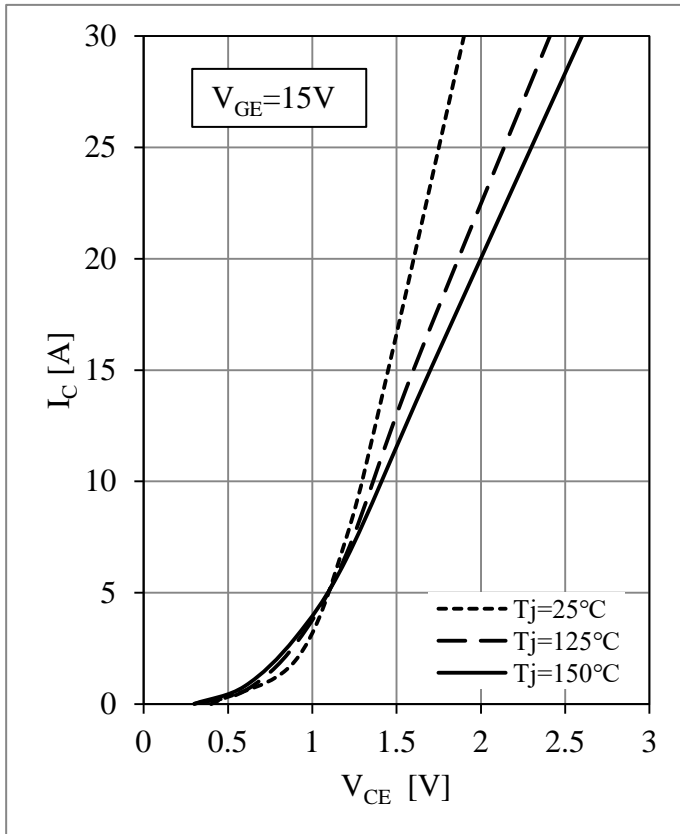

Fig 1. IGBT-inverter Output Characteristics

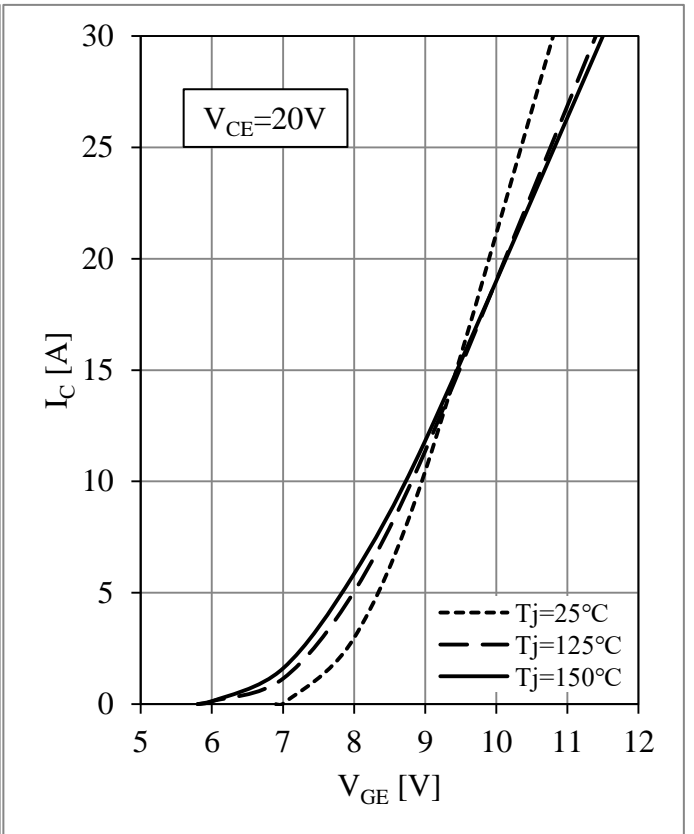

Fig 2. IGBT-inverter Transfer Characteristics

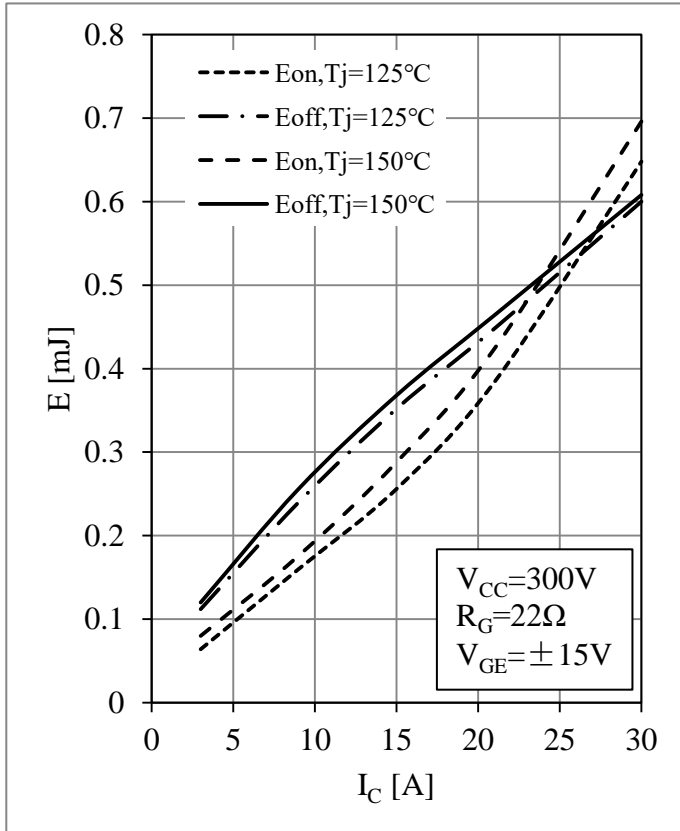

Fig 3. IGBT-inverter Switching Loss vs. I_C

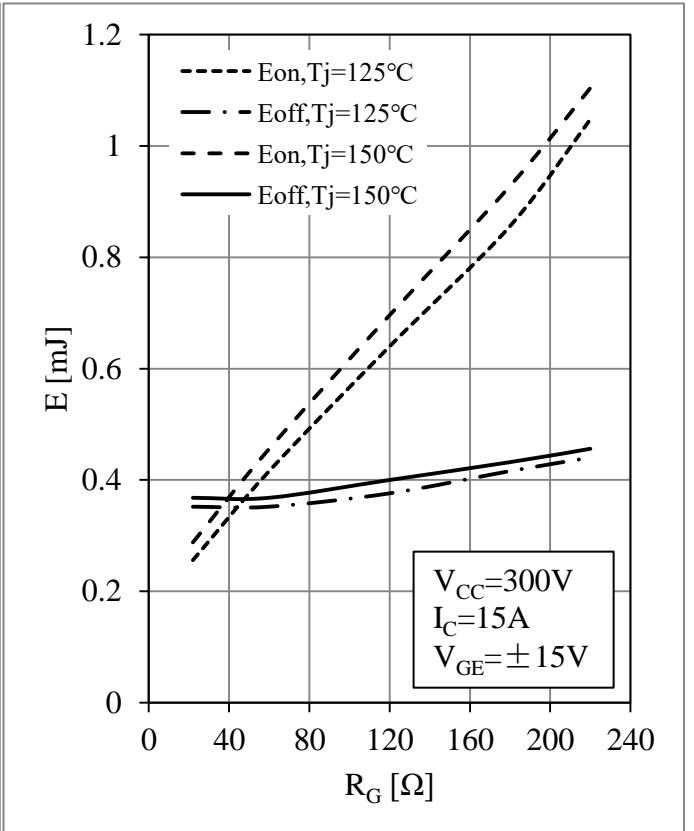

Fig 4. IGBT-inverter Switching Loss vs. R_G

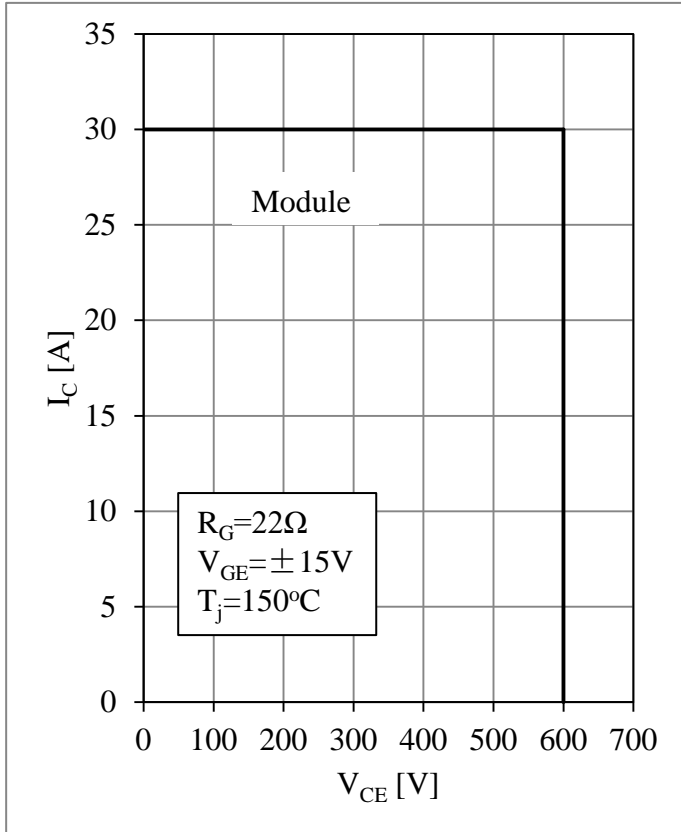

Fig 5. IGBT-inverter RBSOA

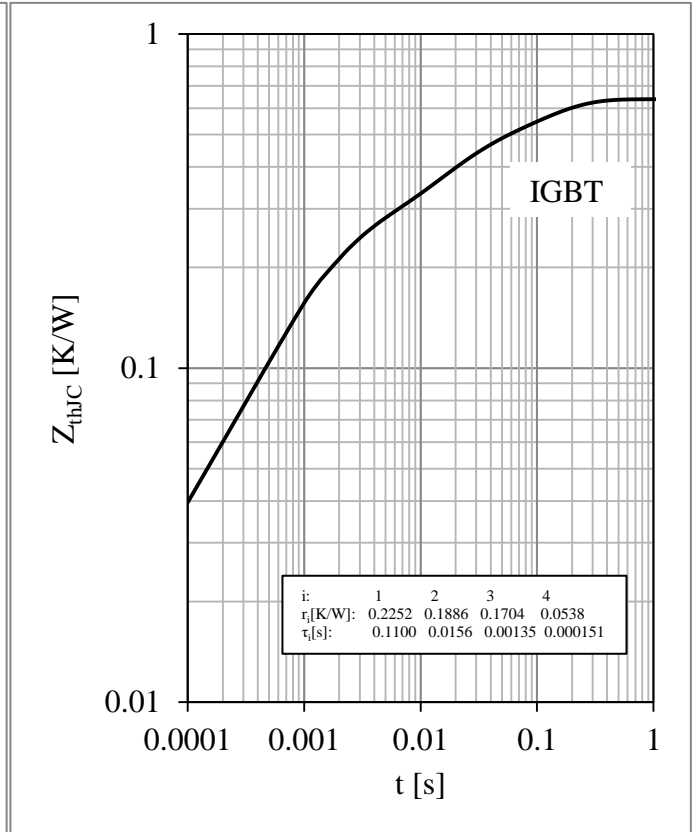

Fig 6. IGBT-inverter Transient Thermal Impedance

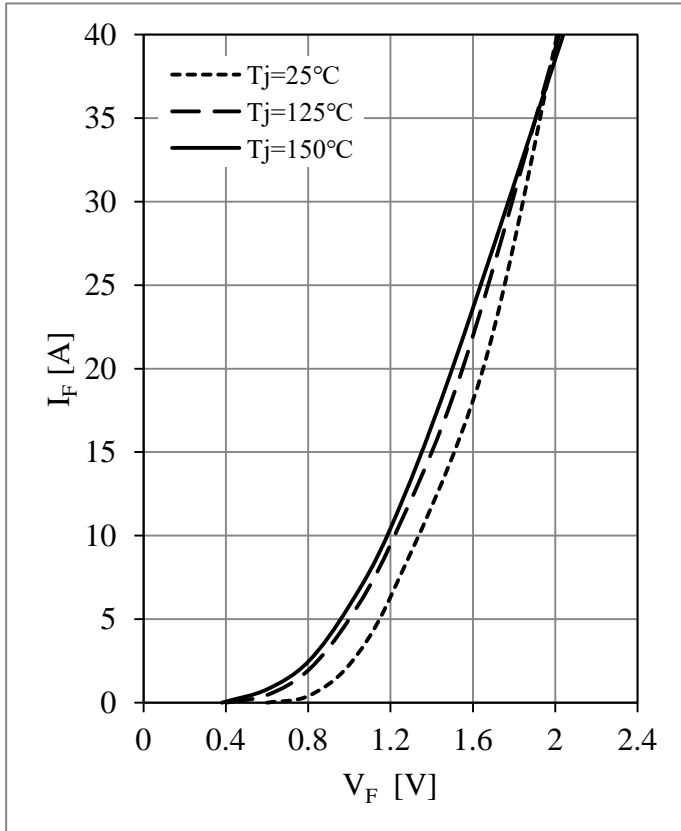

Fig 7. Diode-inverter Forward Characteristics

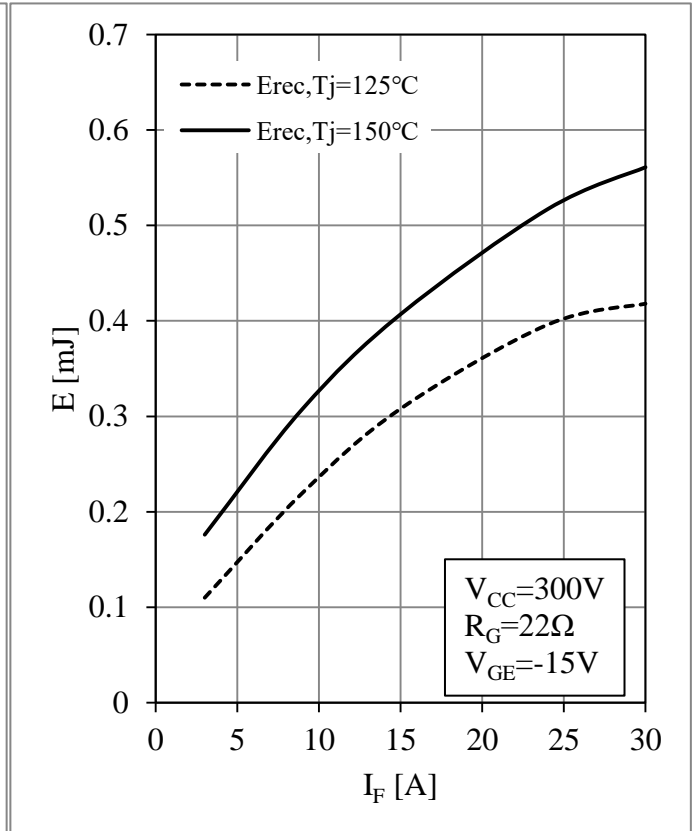

Fig 8. Diode-inverter Switching Loss vs. I_F

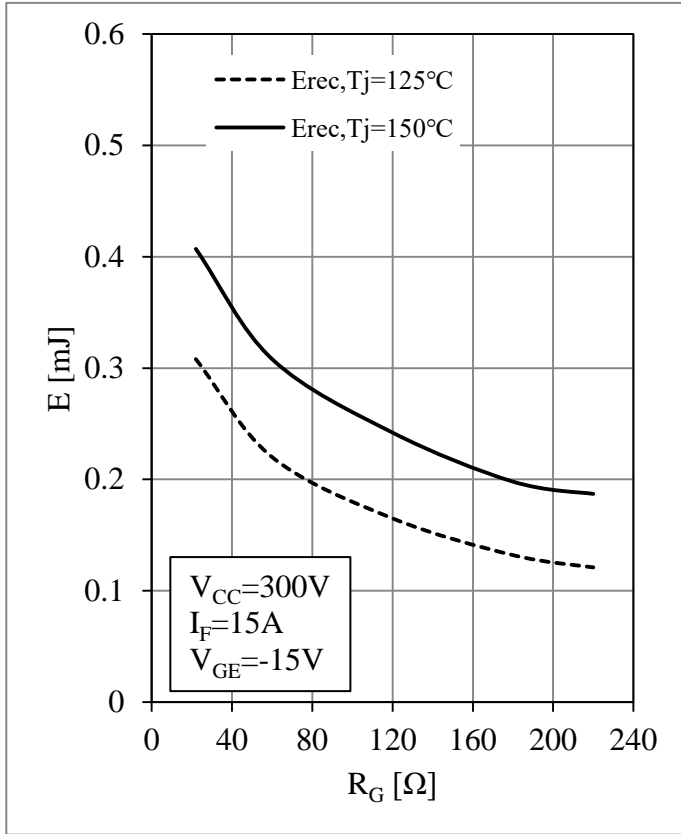

Fig 9. Diode-inverter Switching Loss vs. R_G

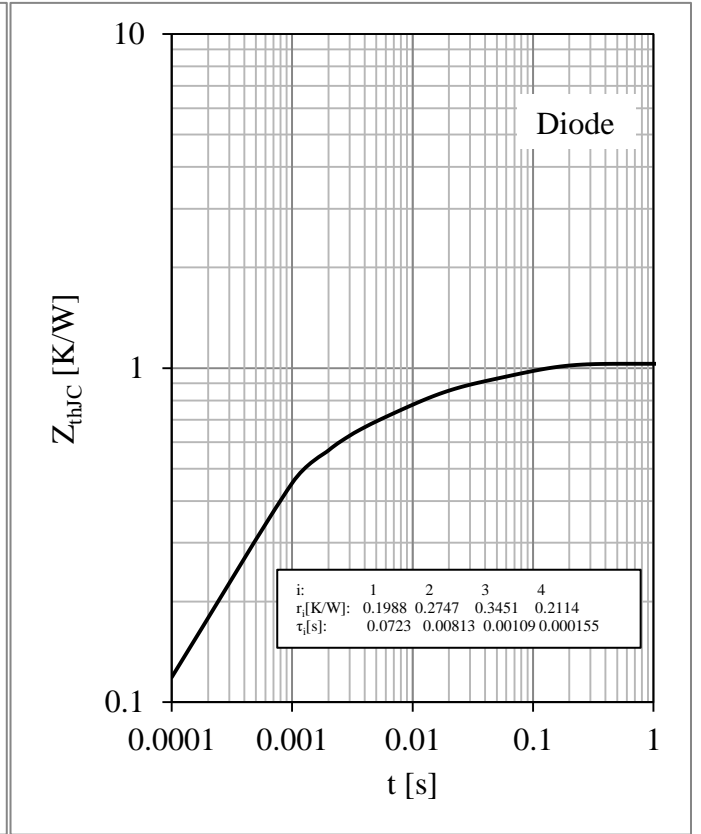
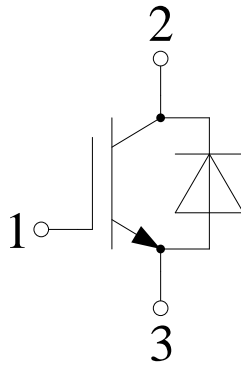

Fig 10. Diode-inverter Transient Thermal Impedance

Circuit Schematic



Package Dimensions

Dimensions in Millimeters

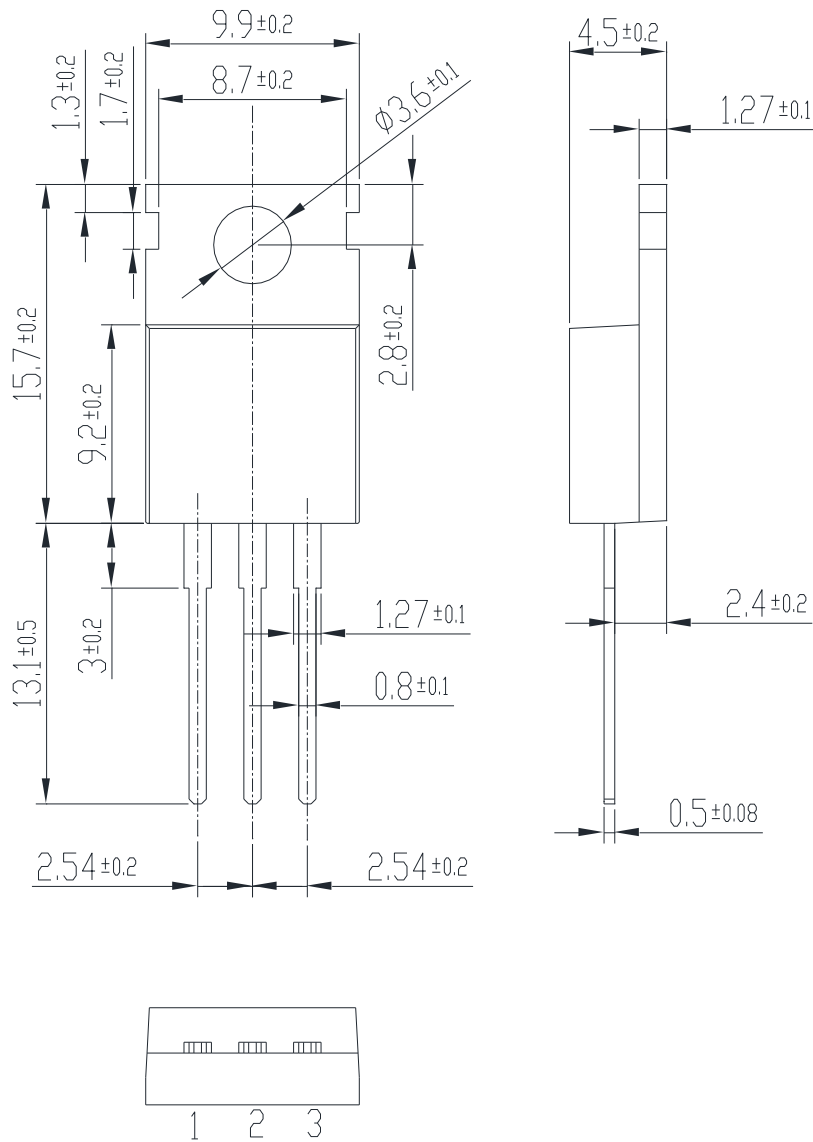

Terms and Conditions of Usage

The data contained in this product datasheet is exclusively intended for technically trained staff. you and your technical departments will have to evaluate the suitability of the product for the intended application and the completeness of the product data with respect to such application.

This product data sheet is describing the characteristics of this product for which a warranty is granted. Any such warranty is granted exclusively pursuant the terms and conditions of the supply agreement. There will be no guarantee of any kind for the product and its characteristics.

Should you require product information in excess of the data given in this product data sheet or which concerns the specific application of our product, please contact the sales office, which is responsible for you (see www.powersemi.cc), For those that are specifically interested we may provide application notes.

Due to technical requirements our product may contain dangerous substances. For information on the types in question please contact the sales office, which is responsible for you.

Should you intend to use the Product in aviation applications, in health or live endangering or life support applications, please notify.

If and to the extent necessary, please forward equivalent notices to your customers.
Changes of this product data sheet are reserved.